



SEAGATE

Exos[®] CORVAULT 5U84 Hardware Installation and Maintenance Guide

Abstract

This guide describes initial hardware setup for Seagate Exos CORVAULT 5U84 controller enclosures and disk enclosures. It also describes removal and installation of customer-replaceable components. The guide is intended for use by storage system administrators familiar with servers and computer networks, network administration, storage system administration and configurations, storage area network management, and relevant protocols.

Part Number: 206113500-00
Revision: A
Published: September 2023

© 2023 Seagate Technology LLC or its affiliates. All rights reserved. Seagate, Seagate Technology, and the Spiral logo are registered trademarks of Seagate Technology LLC in the United States and/or other countries. CORVAULT and Exos are either trademarks or registered trademarks of Seagate Technology LLC or one of its affiliated companies in the United States and/or other countries. All other trademarks or registered trademarks are the property of their respective owners. When referring to disk capacity, one gigabyte (GB) equals one billion bytes, one terabyte (TB) equals one trillion bytes, and one petabyte (PB) equals one thousand terabytes. Your computer's operating system may use a different standard of measurement and report a lower capacity. In addition, some of the listed capacity is used for formatting and other functions, and thus will not be available for data storage. All coded instruction and program statements contained herein remain copyrighted works and confidential proprietary and trade secret information of Seagate Technology LLC or its affiliates. Any use, derivation, disassembly, reverse engineering, dissemination, reproduction, or any attempt to modify, prepare derivative works, reproduce, distribute, disclose copyrighted material of Seagate Technology LLC, for any reason, in any manner, medium, or form, in whole or in part, if not expressly authorized, is strictly prohibited. Seagate reserves the right to change, without notice, product offerings or specifications.

Regulatory and compliance information

For the latest regulatory and compliance information see www.seagate.com/support. Scroll down to the Compliance, Safety and Disposal Guide link.

Contents

1 Introduction	8
Knowledge prerequisites	8
Product documentation and support	8
Intended audience	8
2 System overview	9
Storage enclosure components	9
Storage enclosure chassis	9
5U enclosure components	9
Controller module components	12
3 Initial install preparations	14
Installation checklist	14
Complete installation prerequisites	15
4 Installation of 5U enclosures	17
Unpack and prepare the 5U enclosure	17
Install the 5U rackmount rail kit	18
Mount the 5U enclosure into the rack cabinet	21
Access a drawer	24
Populate the 5U enclosure	25
Test enclosure electrical earth connection	26
Route 5U enclosure data cables and power cords	26
Route 5U enclosure host cables	26
Route 5U enclosure power cords	27
5 Operation of 5U enclosures	29
Apply power to the 5U enclosure	29
Remove power from the 5U enclosure	31
Interpret system LEDs	31
Interpret 5U enclosure operator's panel LEDs	31
Interpret drawer LED panels	32
Interpret controller module LEDs	33
6 Storage enclosure management	35
Command-line interface usage	35
Install a device driver	36
Configure the management host for serial communication	36
Connect to a controller module for configuration	38
Storage Management Console usage	40
Access the web-based management interface	41

Complete the preboard and onboard process	41
7 Hardware installation and configuration issues	43
Address initial start-up issues	43
Interpret storage fault LEDs	44
5U84 enclosure fault LEDs	44
Identify 5U enclosure fault conditions	49
Isolate hardware and connectivity faults	50
Isolate system application faults	51
Take corrective action for 5U enclosures	51
8 In-service field maintenance for 5U enclosures	55
Replace a 5U enclosure drive module in its carrier	56
Replace a 5U enclosure controller module	60
Replace a 5U fan cooling module	63
Replace a 5U power supply unit	64
A Technical specifications	68
B Standards and regulations	70
International standards	70
WEEE recycling	70
Index	71

Figures

Figure 1	5U84 front panel area	10
Figure 2	5U84 rear panel area	11
Figure 3	Profile and top views of fully populated 5U84 drawers	12
Figure 4	Controller module ports, sample SAS 4-port	13
Figure 5	Default belt straps already around the 5U storage enclosure	17
Figure 6	5U left and right rail components	19
Figure 7	Insertion of 5U front mount bracket screw	20
Figure 8	Insertion of 5U rear mount bracket screws	20
Figure 9	Alignment between 5U chassis and rails, minus rear components for clarity	22
Figure 10	Secure chassis operator's panel to rack posts	23
Figure 11	5U rear chassis connection to outer rails, detail, minus rear components for clarity	23
Figure 12	Safety lock to release left drawer slide rail (lower drawer used for relational clarity)	24
Figure 13	Carrier latch features	25
Figure 14	Release latch open and unlocked	25
Figure 15	Release latch properly locked	25
Figure 16	Sample data and management cabling among 5U controllers and host system switches	27
Figure 17	5U power cord routing to independent power distribution units	28
Figure 18	Route 5U power cords to redundant PDUs	30
Figure 19	Route 5U power cords to redundant PDUs	30
Figure 20	5U84 operator's panel LEDs	32
Figure 21	5U84 drawer LED panel	33
Figure 22	Controller module LEDs applicable to all variations	34
Figure 23	Port LEDs for SAS controller modules	34
Figure 24	USB ports on sample SAS 4-port controller module	35
Figure 25	5U84 operator's panel fault LEDs	45
Figure 26	5U84 drawer fault LEDs on drawer LED panel	46
Figure 27	Drive fault LED on carrier bezel	46
Figure 28	Controller module fault LEDs	47
Figure 29	Fan cooling module fault LEDs	48
Figure 30	Power supply unit fault LEDs	48
Figure 31	Drive fault LED on carrier bezel	56
Figure 32	Operator's panel	57
Figure 33	Drawer panel	57
Figure 34	Drawer release and access	57
Figure 35	Carrier latch features	58
Figure 36	Removal of drive in its carrier	58
Figure 37	Replacement of drive in its carrier	59
Figure 38	Release latch open and unlocked	59

Figure 39	Release latch properly locked	59
Figure 40	Safety lock to release left drawer slide rail of lower drawer	60
Figure 41	Controller module LEDs to examine for fault conditions	61
Figure 42	Controller module removal, left (SAS 4-port version)	62
Figure 43	Replacement controller module (SAS 4-port version)	62
Figure 44	Fan cooling module fault LEDs	63
Figure 45	Fan cooling module removal	64
Figure 46	Replacement fan cooling module	64
Figure 47	Power supply unit fault LEDs	65
Figure 48	Power supply unit removal	66
Figure 49	Replacement power supply unit	66

Tables

Table 1	Storage enclosure components	9
Table 2	Installation checklist tasks	14
Table 3	Fault LED prioritization	31
Table 4	Methods of access to controller module	35
Table 5	Interface options	35
Table 6	Supported terminal emulator applications	36
Table 7	Terminal emulator serial port hex codes	36
Table 8	Sample Linux Minicom serial port parameter settings	37
Table 9	Terminal emulator port connection settings	38
Table 10	Factory default network port IP addresses	38
Table 11	Supported browsers	40
Table 12	5U enclosure non-fault conditions	49
Table 13	5U enclosure corrective action for fault conditions	52
Table 14	5U enclosure time limits for FRU replacement	55
Table 15	Storage enclosure dimensions	68
Table 16	Storage enclosure FRU weights	68
Table 17	Environmental specifications	68
Table 18	Power specifications	69
Table 19	Standard and approvals	70

1 Introduction

Seagate Exos storage enclosures combine strong performance with high reliability, flexibility, and manageability. Powerful and compact, the LX2 series expandable storage solution supports business with high-capacity and high-availability options.

The system is designed for high availability (HA), with no single point of failure for data or power. Controller modules (CMs) are Storage Bridge Bay (SBB) v2.1 compatible for interconnects, power budgets and rails, form factors, and footprints.

All Seagate storage enclosures contain one or more CMs, which each contain a Hewitt Lake processor, 16GB of cache, and a custom RAID acceleration ASIC.

⚠ WARNING! Heed all warnings and cautions on labeling and throughout this guide to reduce risk of personal injury or damage to equipment. You must adhere to all safety requirements in this document. Some relate to the entire system, some to the rack, some to the storage enclosure, and others to the FRUs within it.

Knowledge prerequisites

Make sure you have the appropriate knowledge base prior to product installation or service.

- Server system administration
- Storage system configuration
- Storage area network (SAN) management
- Ethernet protocol
- RAID technology
- Redfish Management protocol

Product documentation and support

To obtain the following documents, videos, and other product information, visit www.seagate.com/support.

Content description	Document	Seagate QR codes
Product enhancements, bug fixes, and known issues	Release Notes	 Documentation, Support
Overview of product shipkit contents and setup support	Getting Started*	
Installation of the rail kit and enclosure into a rack	Rackmount Guide*	
Initial installation of hardware, and component replacement	Hardware Installation and Maintenance Guide	
Configuration, management with the web browser interface	Storage Management Guide	
Configuration, management with the command-line interface	CLI Reference Guide	
Event codes and recommended actions	Event Descriptions Reference Guide	
Compatibility information for the product	Compatibility Interop Matrix	
Regulatory compliance, safety, and disposal information	Compliance, Safety, and Disposal Guide	
*Printed document included in the shipkit		

Intended audience

This guide is for software integration providers, storage installation professionals, and system administration personnel.

2 System overview

The Seagate Exos storage series enclosures consist of a sheet metal chassis that contains an integrated midplane and module runner system. You can mount the storage enclosure into a standard 19-inch rack cabinet, occupying five (5U) EIA rack space units. All plug-in modules are hot-swappable, but you must adhere to all safety precautions and time limitations.

Table 1 Storage enclosure components

Type	Typical set of plug-in modules
5U84 storage enclosure	5U chassis and rackmount railkit: Contains two drawers, each with 42 drive modules
	84 3.5-inch or 2.5-inch drive modules with adapters in carriers
	Two controller modules (CMs)
	Five fan cooling modules (FCMs)
	Two power supply units (PSUs)
	Four sideplane printed circuit boards (PCBs), two per drawer
	<i>Authorized service personnel only</i>

 **CAUTION** Make sure you are not connected to power at any time during installation procedures.

 **CAUTION** Only operate the storage enclosure in a dust-free environment to meet temperature control and airflow requirements.

For optimum function, use the high availability (HA) model that requires dual paths for data and power to increase fault tolerance and minimize single points of failure. This manual assumes HA model system integration using a fully populated storage enclosure.

Storage enclosure components

All Seagate Exos storage enclosures have 2 main access points:

1. **Front panel area** — Contains the operator's (ops) panel and access, by opening a drawer, to drive modules in their carriers (DDICs)
2. **Rear panel area** — Contains controller modules and methods for cooling and powering the storage enclosure

Storage enclosure chassis

Chassis sheet metal is bonded and riveted together and free from non-conductive coatings. Each chassis is designed specifically for mounting in a rack cabinet.

5U enclosure components

The 5U84 chassis retains two sliding drawers, so has drawer panels that augment the operator's (ops) panel on the left rack ear flange. Each drawer has its own set of dedicated connectors behind the midplane that allow continuous operation, even if the drawer is extended to the fully open service position or closed with the drawer latch engaged.

The front panel area is the primary physical user interface. Closely watch the ops and drawer panels for status.

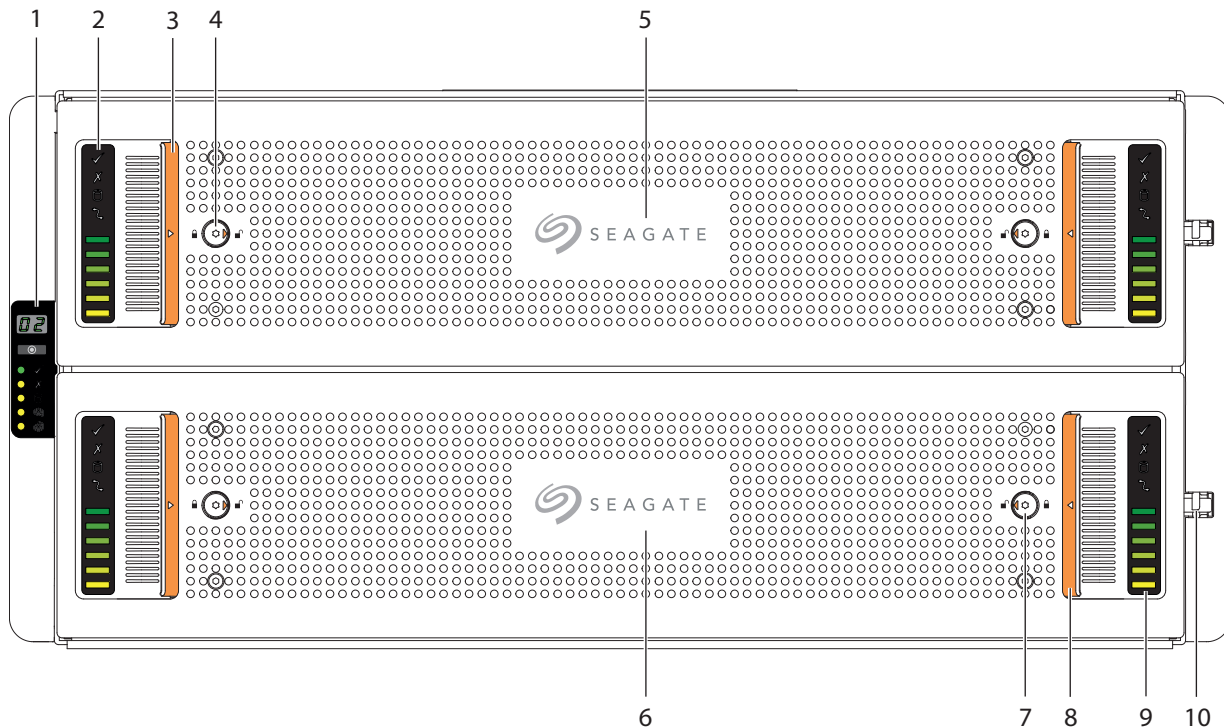

Item	Description	Function
1	Operator's (ops) panel	Connects to midplane, provides users with storage enclosure information and status
2	Drawer left sideplane indicators	Registers activity for the related drive in its carrier (DDIC) and controller for the drawer's left sideplane
3	Left pull handle in recessed pocket	Provides user access to DDICs contained in drawer
4	Drawer left side anti-tamper lock	Prevents drawer access when locked
5	Top drawer: Drawer 1	Contains DDIC slots logically numbered from 0 to 41
6	Bottom drawer: Drawer 2	Contains DDIC slots logically numbered from 42 to 83
7	Drawer right side anti-tamper lock	Prevents drawer access when locked
8	Right pull handle in recessed pocket	Provides user access to DDICs within the drawer
9	Drawer right sideplane indicators	Registers activity for the related DDIC and controller for the drawer's right sideplane
10	Drawer latch	Latches the drawer closed when properly engaged

Figure 1 5U84 front panel area

The rear panel area provides you access to modules designed for power, thermal cooling, and host connectivity.

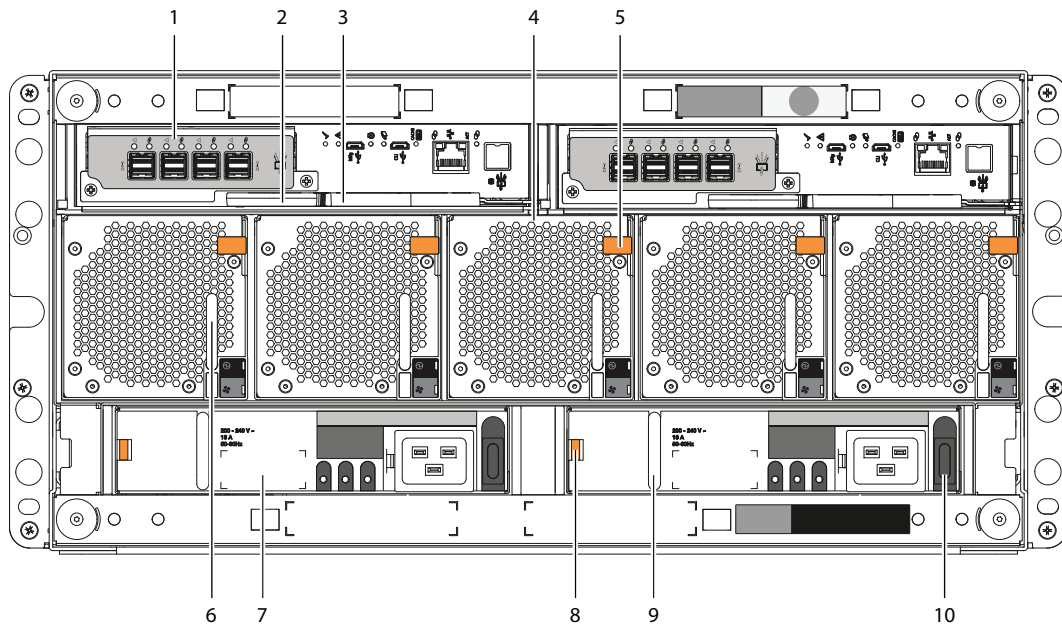

Item	Description	Function
1	Controller module (CM)	Provides data redundancy and is the nerve center of the storage enclosure
2	CM release latch	Provides full contact with midplane or releases CM for inspection and service
3	CM release latch and handle	
4	Fan cooling module (FCM)	Provides redundant regulation of temperature and airflow
5	FCM release latch	Provides full contact with midplane or releases FCM for inspection and service
6	FCM pull handle	
7	Power supply unit (PSU)	Provides redundant regulation of power
8	PSU release latch	Provides full contact with midplane or releases PSU for inspection and service
9	PSU pull handle	
10	PSU power switch	Powers on or off the storage enclosure

Figure 2 5U84 rear panel area

Two sliding drawers hold DDICs and their related sideplanes.

- **Two drawers** each can contain 42 DDICs. Drawer slides lock the drawer in the fully open service position, so require release latch activation to close the drawer.
- **DDICs** slide into 42 slots in each drawer. The upper drawer, Drawer 1, contains slots logically numbered from 0 to 41 in rows moving from top to bottom, then from left to right. The lower drawer, Drawer 2, contains slots logically numbered from 42 to 83, following the same pattern.

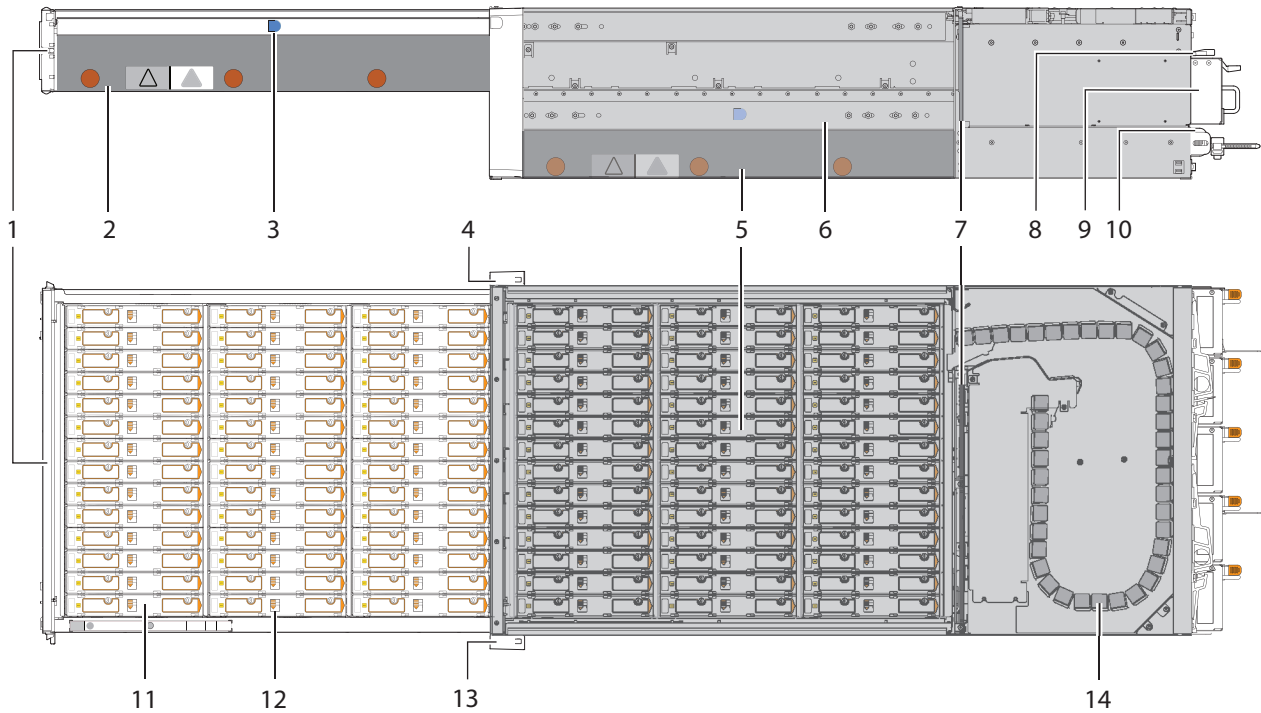

Item	Description	Function
1	Drawer front with keyed anti-tamper lock and 2 drawer latches	Prevents or provides access to DDICs, contains dual drawer panel LEDs for drive activity and fault status
2	Right sideplane	Registers DDIC activity and fault conditions for the primary host path
3	Drawer latch for top drawer: Drawer 1	Locks drawer open to access slots logically numbered from 0 to 41
4	Operator's (ops) panel on left rack ear flange	Connects to midplane, provides users with storage enclosure information and status
5	Bottom drawer: Drawer 2	Contains slots logically numbered from 42 to 83
6	Drawer slide	Supports full extension to service position and access to DDICs
7	Midplane	Connects modules to system controls (<i>Authorized service personnel only</i>)
8	Controller module (CM)	Provides data redundancy and acts as the nerve center of the storage enclosure
9	Fan cooling module (FCM)	Provides redundant regulation of temperature and airflow
10	Power supply unit (PSU)	Provides redundant regulation of power
11	Drive module in its carrier (DDIC)	Provides redundant data storage
12	Locking mechanism	Secures full connection of DDIC
13	Right rack ear cover	Cosmetic
14	Cable management system	Protects cabling associated with the related drawer

Figure 3 Profile and top views of fully populated 5U84 drawers

Controller module components

Both controller modules (CMs) manage the flow of data to and from the storage enclosure. Each CM provides a very specialized, solutions-specific interaction that depends on your system configuration and software implementation, including RAID functions, management functions, failover and failback procedures, and multipath procedures.

The CM has a number of ports and any related LEDs. See "[Interpret controller module LEDs](#)" on page 33.

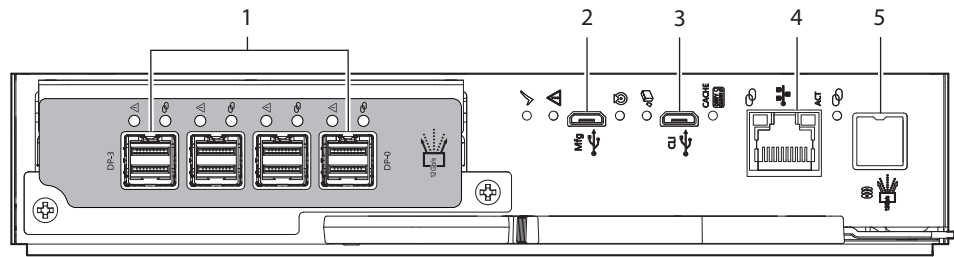

 = SAS 4-port

Item	Description	Function
1	SAS 12Gb/s ports	Serial Attached SCSI (SAS) 12Gb/s data exchange with host computer
2	Mfg USB port	Manufacturing Universal Serial Bus (USB) port: do not use
3	CLI USB port	Serial command line interface port used to manage the system
4	Ethernet port	Ethernet connection to host system
5	SAS expansion port	Not supported

Figure 4 Controller module ports, sample SAS 4-port

3 Initial install preparations

Each storage enclosure installation requires the same amount of preparation to successfully mount it into your industry-standard rack cabinet of up to 1.2m in depth.

⚠ WARNING! Heed all warnings and cautions on labeling and throughout this guide to reduce risk of personal injury or damage to equipment. You must adhere to all safety requirements in this document. Some relate to the entire system, some to the rack, some to the storage enclosure, and others to the FRUs within it.

⚠ CAUTION Use only power cords supplied in the installation kit or those that meet product specifications.

ⓘ IMPORTANT Only a qualified service technician should perform the installation.

Installation checklist

Read this entire section before you begin. You must adhere to all safety requirements prior to and during installation.

⚠ WARNING! Do not attempt to install the 5U storage enclosure into the rack cabinet with drive modules preloaded in the slots. Serious injury and damage could result. Unload any drive modules in storage enclosure slots to a static-protected area. Do not further lighten the storage enclosure by removing other components.

Use this checklist, performing each task only in the sequence presented after successful completion of the prior step.

Table 2 Installation checklist tasks

Step	Task	Reference
1	Complete all installation prerequisites	Identified below
2	Unpack the storage enclosure	"Unpack and prepare the 5U enclosure" on page 17
3	Prepare the site for installation of the storage enclosure into the rack cabinet	"Unpack and prepare the 5U enclosure" on page 17
4	For rackmount installation, temporarily move to a static-protected area any drive modules not installed in the storage enclosure	
5	Install the rackmount kit in the rack cabinet	"Install the 5U rackmount rail kit" on page 18
6	Mount the storage enclosure into the rack cabinet	"Mount the 5U enclosure into the rack cabinet" on page 21
7	Install drive modules in carriers (DDICs) in the storage enclosure	"Populate the 5U enclosure" on page 25
9	Test for safety electrical earth connection	"Test enclosure electrical earth connection" on page 26
10	Connect all host cables	"Route 5U enclosure data cables and power cords" on page 26
11	Connect all power cords	

- **Site preparation**

1. Use the installation checklist.
2. Clear the site for installation and secure a static-protected area.

- **Before storage enclosure installation**
 1. Unpack the storage enclosure in a clear area, using appropriate safety precautions.
 2. Temporarily set aside all drives in carriers (DDICs) into a static-protected area, regardless of how your storage enclosure or drives ship.
 3. Follow all instructions for installing the provided rackmount rails into the rack cabinet.
 4. Review all related warnings before mounting the storage enclosure into the rack.
- **Storage enclosure installation**
 1. Move the storage enclosure onto a suitable mechanical lift. Have three people use the provided belt straps to move the enclosure to a lift.
 2. Use a mechanical lift for positioning the storage enclosure and mounting it into the rack cabinet. Do not use a vacuum lift. To maintain personal and equipment safety, do not use any other method to support the weight of the storage enclosure during installation or maintenance.
 3. Maintain adequate storage enclosure clearances, both front and back.
- **Before FRU installation**
 1. Prior to handling the DDICs, make sure you are static-compliant.
 2. Confirm you can easily reach the slots and you can visually inspect the installation of each DDIC in the enclosure, while safely maintaining your balance.
- **DDIC installation**
 1. Only after you securely mount the storage enclosure in the rack can you retrieve the DDICs from their static-protected area.
 2. Install all DDICs into the proper module slots.
- **Prior to testing the enclosure**
 1. Examine cables and make sure connections are completely secure on both ends.
 2. Adhere to all electrical safety guidelines.

Complete installation prerequisites

The rackmount rails are designed to bear the maximum weight of the storage enclosure when it is properly mounted in a standard rack cabinet. You can install multiple storage enclosures in a single rack cabinet.

 **CAUTION** You must use only the supplied rail kit and related mounting hardware.

To complete installation prerequisites:

1. Prepare the host system for the installation by obtaining access to the following items:
 - a. A host computer with the correct firmware, BIOS, and drivers
 - b. A functioning switch connected to a host computer
 - c. Tested, good cables for host connection that meet storage enclosure requirements
 - d. The provided power cords, which meet power specifications
2. Familiarize yourself with system configuration requirements and the storage enclosure components.

3. Obtain the following:
 - a. An anti-static wrist or ankle strap for handling static-sensitive components
 - b. A static-protected environment for temporary storage of the storage enclosure and the FRUs
 - c. A Torx screwdriver, 6-in length, with T10 and T20 bits
 - d. A flat-bladed screwdriver, 6-in length
 - e. A Philips screwdriver, 6-in length
 - f. A mechanical lift with sufficient clearance and capable of safely lifting the storage enclosure without drive modules
4. Ensure the rack cabinet is suitable for use with the storage enclosure.
 - a. A rack cabinet capable of holding 5U form factors that meets all UL and IEC safety requirements, leveled in all planes with respect to each other
 - b. Adequate clearance in front of the rack cabinet to install the provided rail kit
 - c. A maximum depth of 884mm (34.81 inches) from back of front post to maximum extremity, excluding cabling and door closure considerations
 - d. A rack cabinet that causes a maximum back air pressure of 5 pascals (0.5mm water gauge)
 - e. A rack cabinet constructed to meet the installed weight capacity for the total number of storage enclosures in the rack cabinet, based on a maximum 5U84 enclosure weight of 130kg (287 lb)
 - f. A maximum operating ambient temperature of 35°C (95°F)
5. Secure sufficient staff to assist with the installation. Minimum staff:
 - a. One qualified service technician for the complete installation procedure
 - b. One spotter to assist with the lift and to assist with the installation from the rear of the rack cabinet
 - c. Three people to unpack the storage enclosure and move it onto the mechanical lift

4 Installation of 5U enclosures

Sequentially follow the installation checklist to install your 5U storage enclosure.

Unpack and prepare the 5U enclosure

CAUTION Do not operate a storage enclosure outside the manufacturer's intended use.

- Storage enclosures are suitable for connection to intra-building or non-exposed wiring or cabling only.
- Storage enclosures are suitable for installation in locations where the National Electrical Code (NEC) applies but are not suitable for Outside Plant (OSP) installations.
- Customer facilities must provide for voltages with not more than $\pm 5\%$ fluctuation. Customer facilities must also provide suitable surge protection.

To unpack and prepare the 5U enclosure:

1. Prepare the site for the storage enclosure installation. This includes meeting all product specifications and providing a clean, clear, static-protected environment prior to unpacking the storage enclosure.
2. Complete the following actions to complete inspection of the 5U enclosure:
 - a. Examine packaging for damage. This includes cuts, water damage, or evidence of mishandling during shipment.
 - b. If there is damage, photograph and document it, but do not proceed. Retain all original packaging for returns.
 - c. Remove pallet strapping and all protective foam above the storage enclosure to access it.
3. Slide the plastic bag aside to allow access to the chassis.

WARNING! The box is deep, and the chassis is very heavy. Do not attempt to lift by yourself.

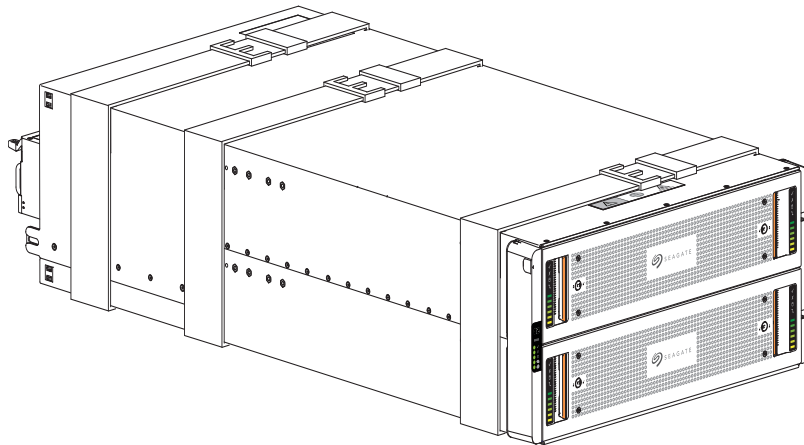



Figure 5 Default belt straps already around the 5U storage enclosure

4. Locate three people to assist in moving the storage enclosure onto the mechanical lift, using an appropriate safe lifting technique to perform the following actions:
 - a. Position one person at the front to grip the front belt strap securely by both loops, not by any portion of the front or rear panel areas.
 - b. Position one person at each rear corner to grip both rear belt straps by the loops on that side.
 - c. Simultaneously lift the storage enclosure, using appropriate safe lifting technique while moving it to a static-protected location, and then to the mechanical lift for mounting to the rack cabinet.
5. Facing the front of the chassis, grasp the right rack flange cover, gently work the cover free, and set it aside in a safe location.
6. Grasp the left rack flange cover, gently work the cover free, and set it aside in a safe location.

Install the 5U rackmount rail kit

The storage enclosure requires rackmount hardware for installation into a standard 1.0m or 1.2m rack and occupies 5 EIA units of rack space (22.22cm or 8.75 inches) per unit. The rail kit contains a left and right rail designed and tested to handle the 5U storage enclosure and provide for installation of multiple enclosures without loss of rack space. Product function and user safety hinge on their proper installation. The following task assumes your rack posts have square mounting holes.

You must take all appropriate rack cabinet safety precautions before mounting a storage enclosure into a rack.

 **CAUTION** Observe all the following directives:

- Always place the rack cabinet on a flat, leveled surface. Do not install a storage enclosure into a rack cabinet until you verify the rack cabinet is level.
- Follow prescribed leveling procedures from the rack cabinet manufacturer.
- Never install or remove from the rack cabinet more than one storage enclosure at a time. This helps prevent the rack cabinet from tipping or falling.
- Verify the rack cabinet meets all safety requirements when configured with storage enclosures.
- Verify connections comply with all electrical requirements.
- Verify the system complies with all temperature and exhaust requirements.

To adhere to safety precautions when mounting a storage enclosure into a rack cabinet:

1. Read and observe all warning and caution labels on the storage enclosure.
2. Verify the rack cabinet is on a flat, leveled surface because any incline or unevenness stresses the rack cabinet and the storage enclosure. A storage enclosure in an uneven rack cabinet resists smooth movement on the rails and possibly distorts the storage enclosure.
3. Verify the rack cabinet design supports the total weight of storage enclosures and has stabilizing features to prevent the rack cabinet from tipping or being pushed over during installation or normal use.
4. Do not lift the storage enclosure without a mechanical lift. No single person should ever lift a storage enclosure without assistance.
5. Mount storage enclosures into the rack cabinet from the bottom to the top during installation.
6. Locate lighter storage enclosures above heavier ones to maximize stability.
7. Remove storage enclosures from the top of the rack cabinet to the bottom when emptying it.

Required equipment	Qty	Identification
Outer rails, properly oriented	2	N/A
#2 Phillips-head screwdriver, 6-in length	1	N/A
(Optional) 8mm nut driver, 6-in length	1	N/A
Phillips-head screw, M5 x 15, 8mm hex flange	8	

To install the 5U rackmount rail kit:

1. Remove both rail assemblies from their packaging.
2. Orient the rail with the LH FRONT embossed on it to your left, the other with the RH FRONT embossed on it to your right, and each emboss toward you, facing inward.

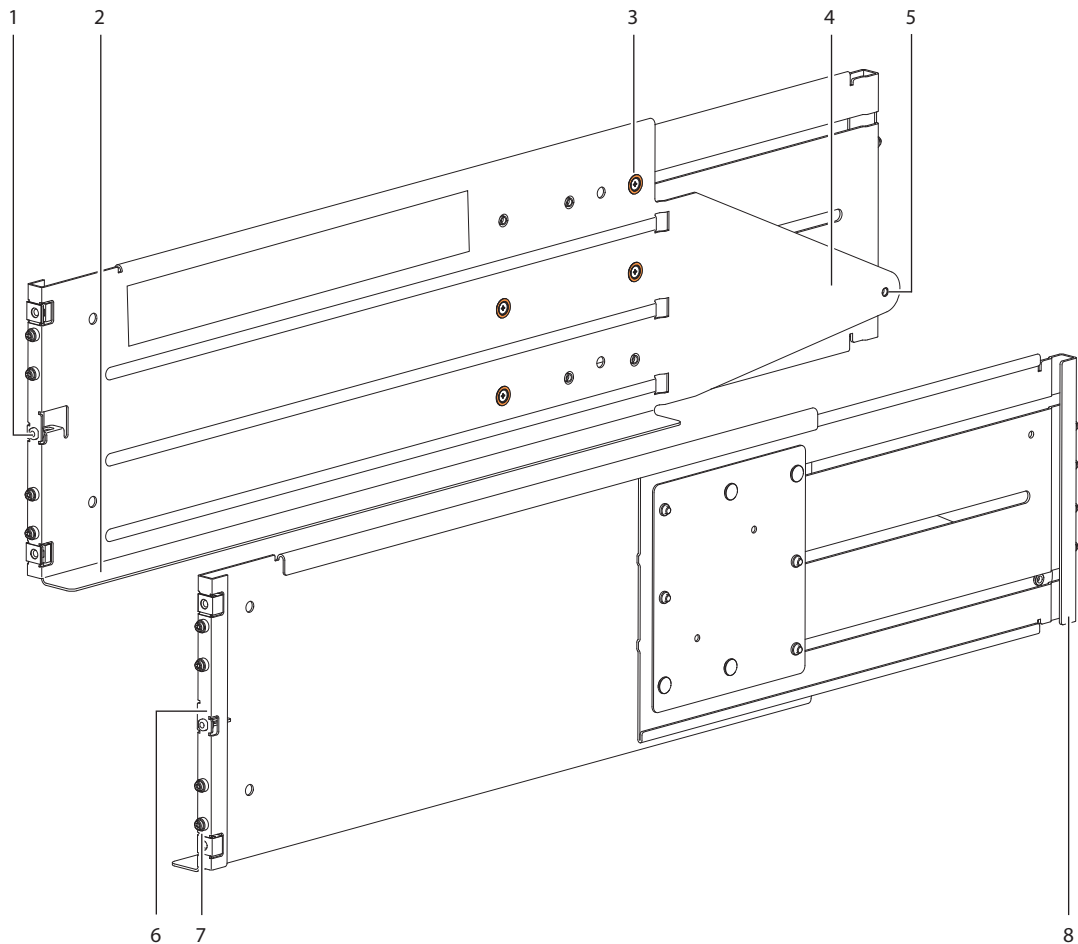

Item	Description	Item	Description	Item	Description	Item	Description
1	Left front mount bracket	3	Rail slide set screw	5	Rear mount	7	Rack pin
2	Left rail shelf	4	Left rear tail	6	Right front mount bracket	8	Right rear mount bracket

Figure 6 5U left and right rail components

3. Loosen, but do not remove, all 4 rail slide set screws on each rail with a Philips screwdriver.

4. Select the left rail, then face the left side of the rack cabinet and slide the front mount bracket pins into the desired slots in the front rack post.
5. Insert a Phillips-head M5 x 15 screw through the rack post into the center of the front rack mount bracket and barely tighten against the front rack post, using an 8mm nut driver or a Philips screwdriver.

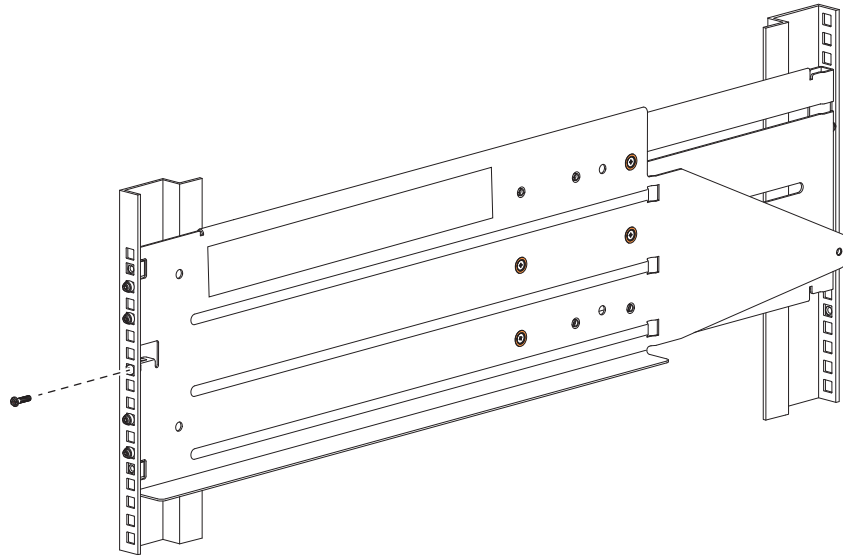

Figure 7 Insertion of 5U front mount bracket screw

6. Extend the length of the rail until the rear mount bracket pins in the mirror location on the rear rack post.
7. Verify that the rails are level at the same height on both rack posts, and that all location pins fully seat in the rack posts.
8. Facing the rear of the rack cabinet, insert 2 Phillips-head M5 x 15 screws into the top and bottom holes of the rear mount bracket.

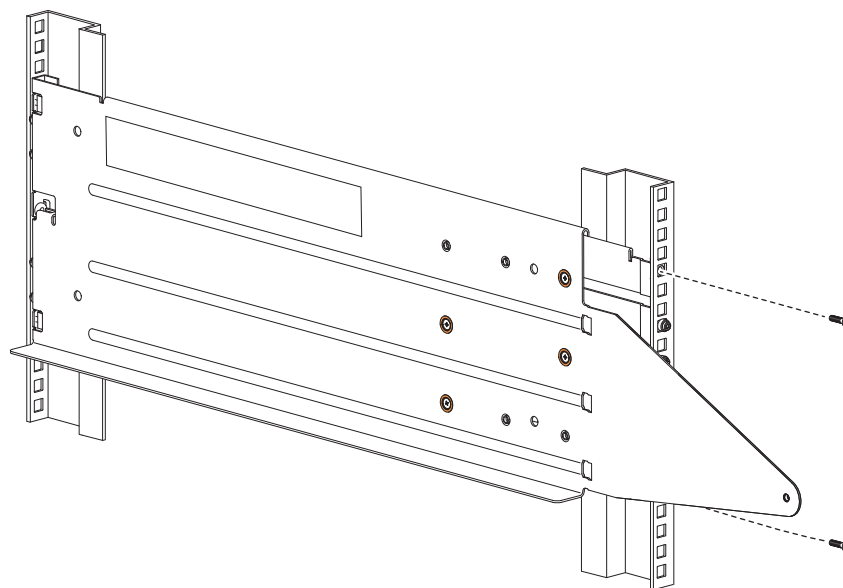

Figure 8 Insertion of 5U rear mount bracket screws

9. Hand tighten firmly against the rack post using an 8mm nut driver or a Philips screwdriver.

10. Facing the front of the rack cabinet, hand tighten both of the Phillips-head M5 x 15 screws using an 8mm nut driver or a Phillips screwdriver so that the hex head flanges are flush with the front rack post.
11. Fix the adjusted length of the left rail by hand tightening all 4 rail slide set screws using a Phillips screwdriver.
12. Repeat the process for the right rail.



Mount the 5U enclosure into the rack cabinet

⚠ WARNING! Serious injury and mechanical failure can result if you do not adhere to rack cabinet safety precautions.

- To avoid risk of death or injury from tipping the rack, follow all rack installation guidelines, securing the rack cabinet to the floor with a concrete anchor kit.
- To avoid catastrophic failure of the rack assembly, never exceed rack cabinet weight limits.
- Entirely support the storage enclosure with the mechanical lift until the enclosure is in the storage position.
- Follow local occupational health and safety guidelines and meet all requirements for manual material handling.

Mounting the storage enclosure into the rack cabinet is the most critical of the installation procedures and requires your full attention. Safety and hardware longevity depend on rails' smooth function and correct implementation of this task.

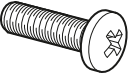
- Make sure there is sufficient clearance for a technician and the storage enclosure when a drawer is fully extended.
- Observe rack cabinet weight limits.
- Fill the rack cabinet from the bottom to the top, with the heaviest equipment at the bottom.
- Make your approach with the mechanical lift level, straight, and parallel to the rack cabinet. Any skew, warp, or tilt prevents the storage enclosure from properly resting on the rackmount shelf in the rack cabinet.

Required equipment	Qty	Identification
Mechanical lift	1	N/A
Storage enclosure with attached inner rails	1	N/A
Rack cabinet with installed outer rails	1	N/A
#2 Phillips-head screwdriver, 6-in length	1	N/A
(Optional) 8mm nut driver, 6-in length	1	N/A
Panhead screw, M5 x 8, #2	4	
Panhead screw, 10-32 X 3/4-in	6	
Lock washer, M5, Type B	6	
Washer, M5, 10 x 1.6mm	6	

To mount the 5U enclosure into the rack cabinet:

1. Confirm that the outer rails are properly and securely installed in the rack cabinet.
2. Confirm that the storage enclosure does not contain any drives, so the chassis has empty drawers.

3. Complete the following actions to position the mechanical lift and the 5U chassis:
 - a. Using proper safety precautions, position the 5U chassis on the mechanical lift perpendicular to the lift wheels.
 - b. Move the mechanical lift into position perpendicular to the rack cabinet so that the storage enclosure is parallel to the opening and is a minimum of 12.7cm to 17.8cm (5 to 7 inches) away from the rack cabinet.
 - c. Adjust the mechanical lift height to be as close as possible to the allocated 5U location.
 - d. Moving only the 5U chassis, position it so the chassis aligns with the outer rails in the rack.

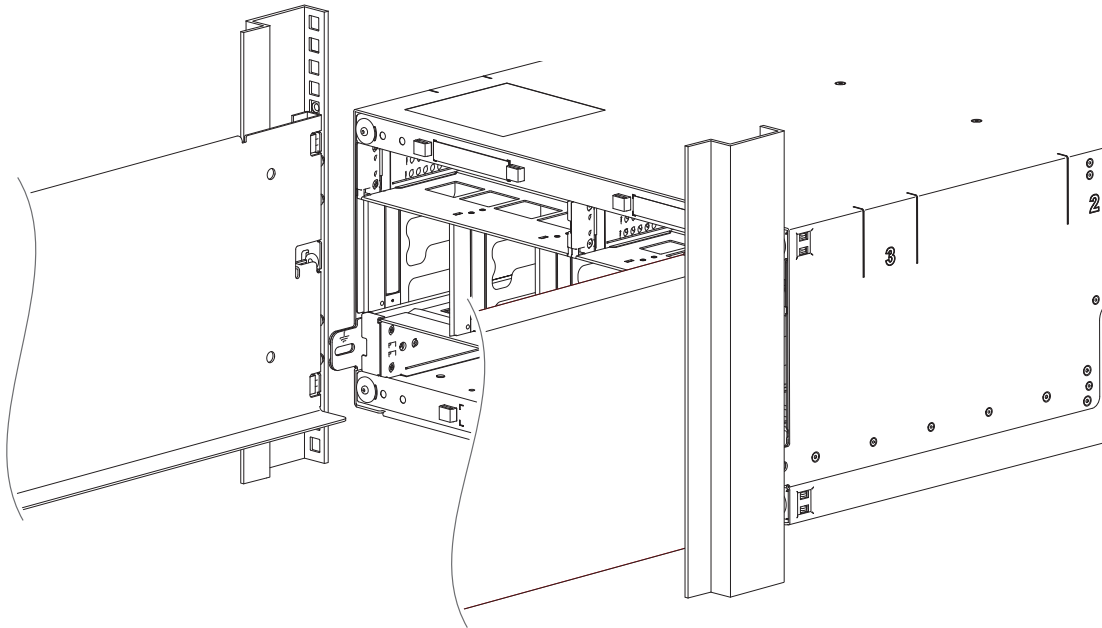

Figure 9 Alignment between 5U chassis and rails, minus rear components for clarity

4. Complete the following actions to properly secure the 5U chassis on its rails:
 - a. Keep the 5U chassis stationary on the mechanical lift.
 - b. Conduct a visual inspection of both sides to verify the bottom of the storage enclosure chassis rests squarely on the front of the bottom shelf of the outer rail and that the direction is straight in, not at an angle.
5. Complete the following actions to insert the 5U chassis into the rack cabinet:
 - a. Facing the front of the enclosure, carefully exert even pressure on both sides of the storage enclosure front, inserting the storage enclosure until the rack ear flanges are flush with the front rack posts.
 - b. Carefully lower the mechanical lift.
 - c. Thoroughly examine the rack rails for issues such as bowing, scraping, resistance, or indicators of misalignment.
6. Complete the following actions to secure the 5U chassis:
 - a. Remove and set aside the operator's (ops) panel.
 - b. Thread a lock washer and then a washer onto each of 2 Panhead 10-32 screws.
 - c. Facing the front of the enclosure, insert a Panhead 10-32 screw with washers into the top and bottom holes in the ops panel, then hand tighten firmly against front rack post with a Phillips screwdriver.

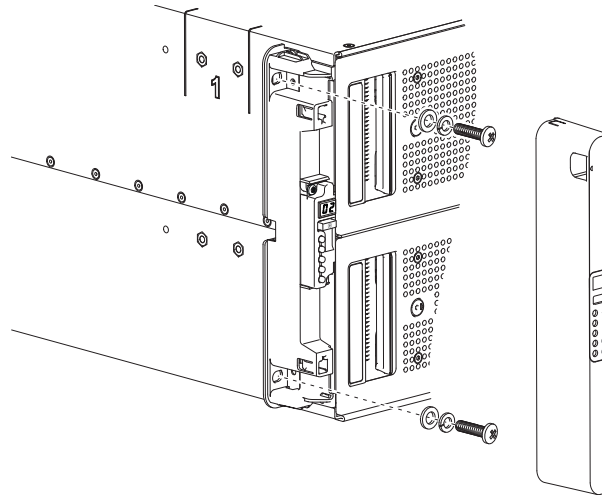

Figure 10 Secure chassis operator's panel to rack posts

- d. Slide the ops panel cover over the left rack ear flange until flush with the rack post.
- e. Repeat the process for securing the right rack ear flange and replacing the right rack ear cover.
- f. Facing the rear of the enclosure, insert and tighten an Panhead M5 x 8 screw through the chassis and into the tail of each outer rail with a Phillips screwdriver to secure the rear of the chassis.

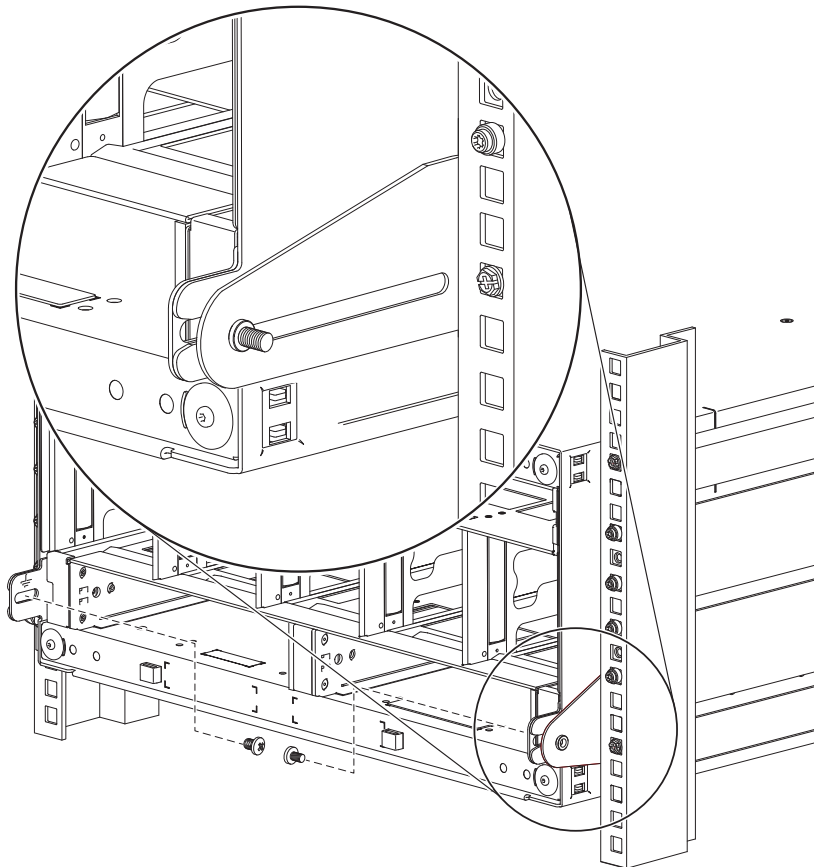

Figure 11 5U rear chassis connection to outer rails, detail, minus rear components for clarity

Access a drawer

Each tamper-resistant drawer contains 42 slots for drives in carriers (DDICs). The drawer supports its DDIC contents and own weight when partially or fully open. A safety latching mechanism prevents access to more than one drawer at a time.

CAUTION Only open a drawer for no more than 10 minutes, or you will compromise airflow and cooling. DDICs are hot-swappable.

To access a drawer:

1. Confirm the drawer is in the unlocked position. If it is locked, use a T20 Torx driver to unlock each drawer pull handle by turning both locks counterclockwise on each drawer.
2. Complete the following actions to open the upper drawer:
 - a. Facing the front of the storage enclosure, press and hold both drawer pull handles while pulling outward.
 - b. Stop as the drawer rails engage the safety lock latches, and then access three rows of slots for drive modules in their carriers (DDICs).
3. Complete the following actions to close the upper drawer:
 - a. Press and hold the safety lock latches with the blue touchpoint at the front of both extended drawer slide rails.

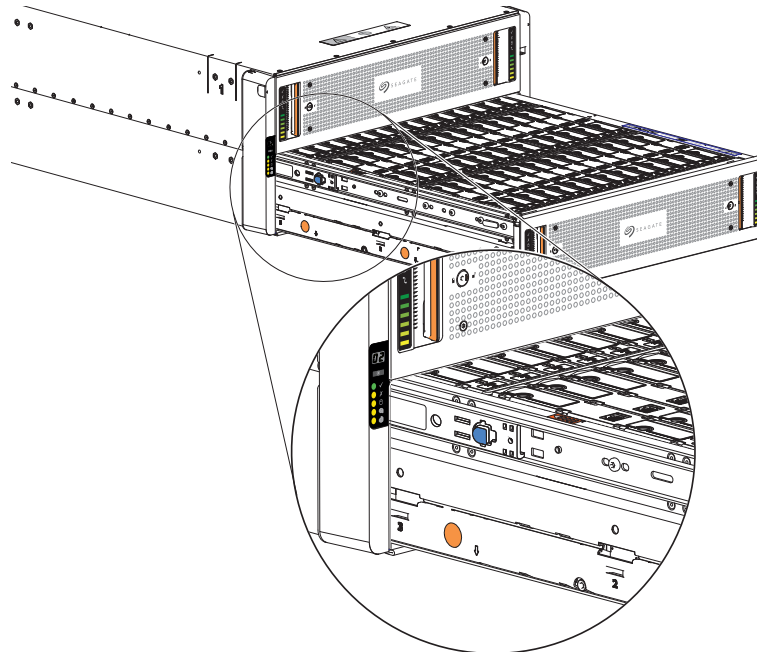

Figure 12 Safety lock to release left drawer slide rail (lower drawer used for relational clarity)

- b. Pressing simultaneously inward, begin sliding the upper drawer back into place until the safety lock clears the opening.
 - c. Placing the heels of both palms against the face of the drawer near the anti-tamper locks, exert even inward pressure until the drawer is almost flush with the rack ear flanges.
 - d. Simultaneously press inward and hold both drawer pull handles as you push the drawer closed until it fully latches.
4. (Optional) Use a T20 Torx driver to lock each drawer pull handle by fully turning both locks clockwise on each drawer, and then confirm the locks properly latched by attempting to open the drawer.

Populate the 5U enclosure

After successfully mounting the 5U chassis into the rack cabinet, populate the storage enclosure.

CAUTION If you partially populate the storage enclosure with drives in their carriers (DDICs), you must comply with several additional requirements.

- You must install a minimum of 14 DDICs. Populate in rows, 14 DDICs at a time, from front to back of the drawer, and alternate between drawers.
 - a. Fill the front row in Drawer 1, then front row in Drawer 2.
 - b. Fill the middle row in Drawer 1, then the middle row in Drawer 2.
 - c. Fill the back row in Drawer 1, then the back row in Drawer 2.

The total number of populated drawer rows cannot differ by more than 1 row.

- Populate rows with DDICs that have the same form factor and same rotational speed.
- Do not mix drive types within the same drawer.

To populate the 5U enclosure:

1. Complete all actions to open the upper drawer. See ["Access a drawer" on the previous page.](#)
2. Complete the following actions to fully populate the upper drawer:
 - a. Select a DDIC and orient it, so the LED is towards the drawer front and the release latch arrow towards the rear.

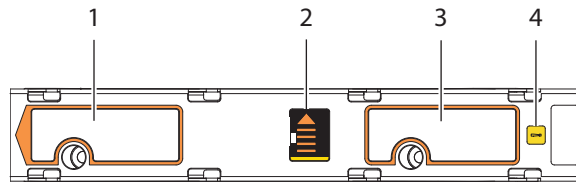

Item	Description	Item	Description
1	Upper portion of carrier latch	3	Lower portion of carrier latch
2	Release latch, release latch arrow, open state	4	Fault condition LED

Figure 13 Carrier latch features

- b. Align the carrier with the first empty drawer slot to the front far left, then lower it fully into the slot.
- c. Push the DDIC down until the top is flush with the top of the slot.
- d. While holding it against the bottom of the slot, slide the top latch toward the rear of the drawer until it locks into place and the DDIC release latch locks.



Figure 14 Release latch open and unlocked



Figure 15 Release latch properly locked

- e. Select the next DDIC, orient it so the LED is towards the drawer front, and insert into the next slot in the same manner.
- f. Repeat, moving to the next slot in the sequence, until you complete the row.

- g. Populate the next two rows in sequence.
- h. Verify that all drives are at the same level and all DDIC release latches are properly locked.

 **CAUTION** Do not proceed to close the drawer unless all DDICs are in a fully locked position or DDIC height can inhibit or completely prevent drawer access once you close it.

3. Complete all actions to close the upper drawer. See "Access a drawer" on page 24.
4. Open the lower drawer and repeat the above DDIC installation process.
5. Following the same drawer closure process, completely close the drawer until it fully latches.

Test enclosure electrical earth connection

After completion of all installation procedures, the storage enclosure is ready for connection to power. You can only connect the storage enclosure to a power source that has a safety electrical earth connection. Have a qualified electrical engineer confirm the earth connection meets the product specifications.

 **CAUTION** If you install multiple storage enclosures in a rack cabinet, the importance of the earth connection increases, since each enclosure increases earth leakage current.

 **IMPORTANT** Only a qualified electrical engineer who meets local and national standards should perform the inspection.

Route 5U enclosure data cables and power cords

When properly connected to autonomous power distribution units (PDUs), power cords provide uninterrupted power to the storage enclosure. Data cables provide an efficient highway for data exchanges to and from the storage enclosure. You must properly route both while adhering to all grounding requirements and electrical safety precautions.

To adhere to electrical safety precautions:

1. Observe the caution labels affixed to the power supply units (PSUs).
2. Confirm PCM input voltage range is 100-240VAC at 50 to 60Hz, then only operate the storage enclosure in that range.
3. You must provide a suitable power source with electrical overload protection to meet technical specification requirements.
4. You must use a provided power cord that has a tested, safe electrical earth connection for storage enclosure power supply.
5. Confirm the storage enclosure connection to earth before applying power to it.
6. Do not operate a storage enclosure with less than the provided 2 PSUs and 5 fan control modules (FCMs, other than to provide in-service maintenance within the required time allotment.

 **IMPORTANT** Use only Cat-6 or above cables with RJ-45 connectors for Base-T connections.

 **IMPORTANT** Use only Seagate approved HD mini-SAS (SFF-8644) x4 data cables that are at least .5m (1.64 feet) in length and do not exceed 3m (9.84 feet) in length to connect to the SAS ports on each controller module.

Route 5U enclosure host cables

Each 5U storage enclosure supports several methods for connectivity to a switch or the host system. Select data cables that best align with available controller module (CM) ports and your host environment.

Fault tolerance and performance are key factors in determining how to best optimize your system and cabling configuration. This topic assumes a fault-tolerant *reverse* cabling method, since it provides a method of maintaining access to all enclosures in the chain, even if one of the enclosures fails or requires removal. If you use a *straight-through* cabling method, optimized for high performance, it is less fault tolerant. When using straight-through cabling, a failed enclosure in the chain prevents access to enclosures further down the chain until you address the fault.

You must comply with all SAS cabling requirements and confirm that they meet all related standards.

- The maximum length of any SAS cable for any configuration is 2m (6.56 feet).

CAUTION Do not create invalid closed loops anywhere along the SAS port cabling configuration. A valid cabling configuration is directional and does not contain any loops between components already in that cabling configuration. An invalid closed loop introduces a circular flow into the cabling configuration that can degrade performance or cause failure.

To route 5U enclosure cables:

1. Route data and management cables from the host system to the best available controller module port for your environment.
 - a. Connect SAS cables from the SAS ports to the host switch or HBA as shown.
 - b. (Optional) Connect an Ethernet cable from the management port to the host as shown.

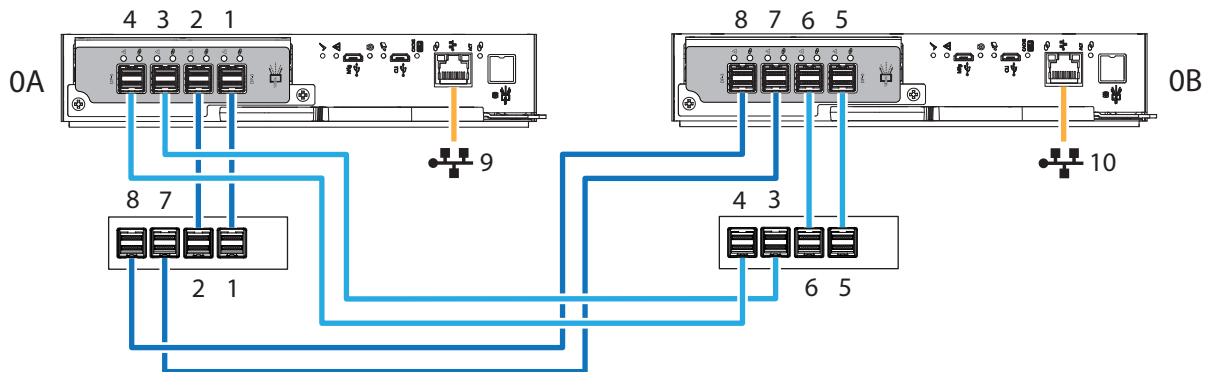

Figure 16 Sample data and management cabling among 5U controllers and host system switches

Route 5U enclosure power cords

This task provides direction to connect supplied power cords to the redundant power supply units (PSUs) connected to an uninterruptible power system. Only connect PDUs to a power source with a safety electrical earth connection.

CAUTION Use only power cords supplied in the installation kit or those that meet product specifications.

CAUTION Adhere to power source and power connection requirements to avoid harm to equipment.

- Only connect the power supply unit (PSU) to power sources that comply with product specifications and labels.
 - Always remove all power connections before you remove a PSU from the storage enclosure.
-

To route 5U enclosure power cords :

1. Select both power cords from the packaging and remove the cable ties.
2. Facing the rear of the rack cabinet, connect a power cord connector to each PSU.
3. Route the left power cord below the left outermost fan and connect the plug to an outlet on an independent power distribution unit (PDU), allowing a minimum of slack.
4. Route the right power cord below the right outermost fan and connect the plug to an outlet on an independent PDU, allowing a minimum of slack.

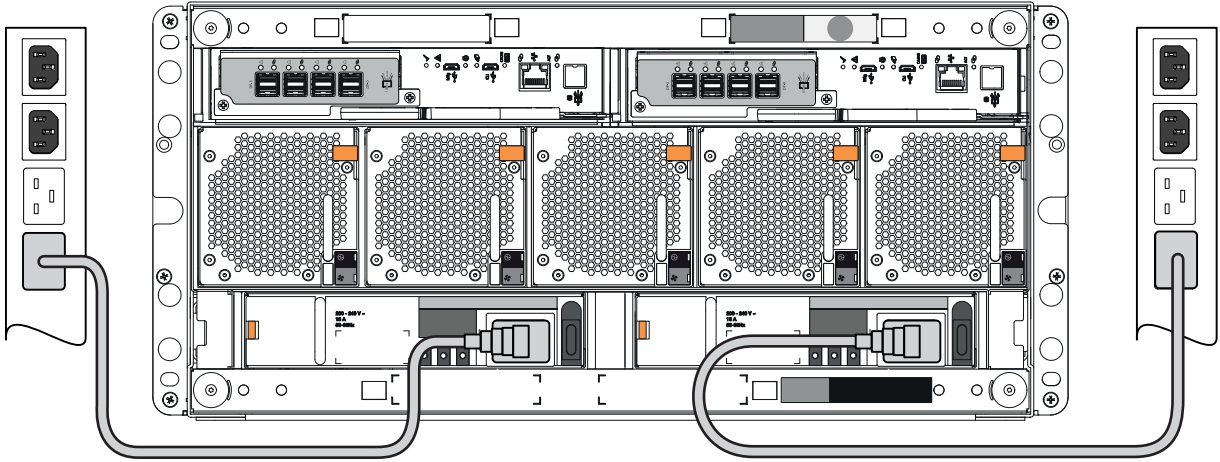



Figure 17 5U power cord routing to independent power distribution units

5. Secure each power cord, using the built-in secure ties on the PSU.
6. Proceed with routing data cables in the next tasks, leaving the power on sequence until after you complete all other cabling tasks and are fully ready to test your connections.

5 Operation of 5U enclosures

 **CAUTION** Only operate the storage enclosure in a dust-free environment to meet temperature control and airflow requirements.

 **CAUTION** If you partially populate the storage enclosure with drives in their carriers (DDICs), you must comply with several additional requirements.

- You must install a minimum of 14 DDICs. Populate in rows, 14 DDICs at a time, from front to back of the drawer, and alternate between drawers.
 - a. Fill the front row in Drawer 1, then front row in Drawer 2.
 - b. Fill the middle row in Drawer 1, then the middle row in Drawer 2.
 - c. Fill the back row in Drawer 1, then the back row in Drawer 2.The total number of populated drawer rows cannot differ by more than 1 row.
 - Populate rows with DDICs that have the same form factor and same rotational speed.
 - Do not mix drive types within the same drawer.
-

Before you power on the storage enclosure, you must take the following actions:

1. Review the installation checklist, confirming the successful completion of the entire sequence.
2. Verify that all drive modules in their carriers (DDICs) are in their correct slots, that you install them in sets of 14, and that you properly engaged them by pressing firmly until each one locks into place on its midplane.
3. Confirm you have met ambient temperature requirements identified in the Environmental Reqs section.
4. Confirm that airflow paths at the front and rear of the enclosure chassis are clear and remain clear.
5. Proceed to the power on task.
6. Load the system OS and appropriate applications to the controller module (CM).
7. Access the software management interface to complete your system setup.

Apply power to the 5U enclosure

The storage enclosure relies on main power provided through separate, independent power distribution. If you lose main power for any reason, the storage enclosure automatically restarts after power restoration.

 **CAUTION** Adhere to the following electrical safety guidelines:

- During installation, never connect a power cord to a power supply unit (PSU) before installing it in the appropriate storage enclosure slot.
 - Only connect the power cord to power that complies with the product specifications within a range of 200 to 240VAC, per the hazardous voltage warning label on the PSU.
 - During service, always remove the PSU from power by disconnecting the power connector before removal of the PSU.
-

! **IMPORTANT** Only after you successfully complete the installation checklist can you complete system setup and begin operation of the storage enclosure.

To apply power to the 5U enclosure:

1. If you removed power to repair the storage enclosure, begin by facing the rear of the rack cabinet and connect the plug for each of the power to an independent power distribution unit (PDU). The second power supply unit (PSU) provides the first PSU with redundant power.

! **IMPORTANT** The storage enclosure design requires two redundant power supply units (PSUs). You must plug each power cord into an independent power distribution unit (PDU) that connects to an uninterruptible power system.

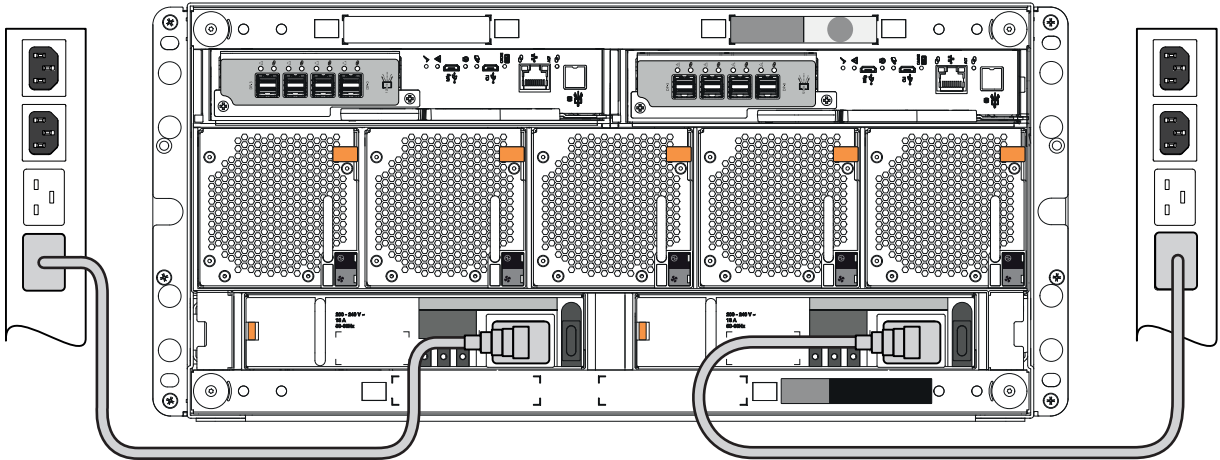

Figure 18 Route 5U power cords to redundant PDUs

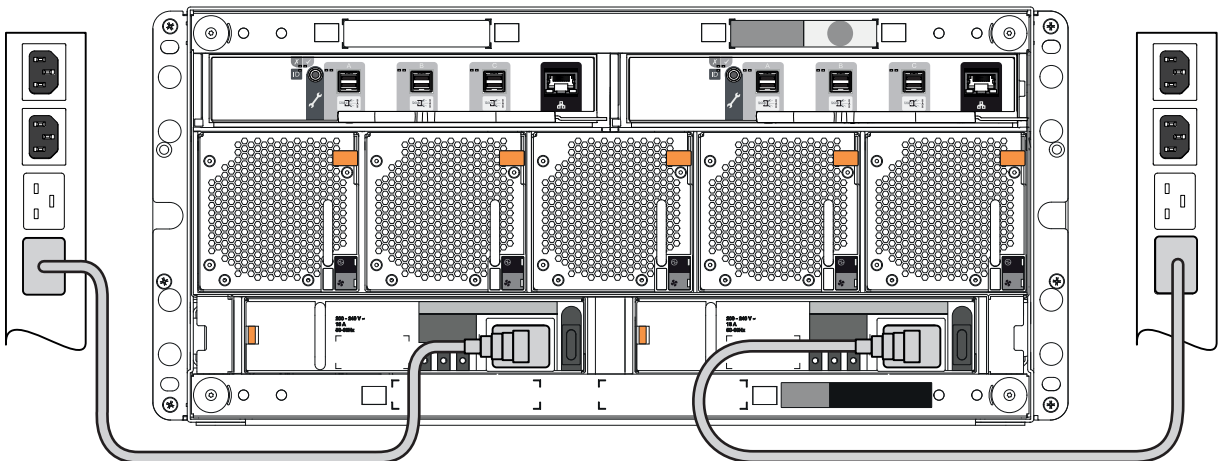

Figure 19 Route 5U power cords to redundant PDUs

2. Press the power switch to the ON position for each power supply unit (PSU).
3. Facing the front, observe the LEDs on the front panel area and confirm the *Power On* LED is in a steady green state. If it is flashing amber, proceed to ["Hardware installation and configuration issues"](#) on page 43.

Remove power from the 5U enclosure

The storage enclosure relies on main power provided through separate, independent power distribution. If you lose main power for any reason, the storage enclosure automatically restarts after power restoration.

You must quiesce all data exchange before removing power to the storage enclosure.

To remove power from the 5U enclosure:

 **CAUTION** Never remove power from a redundant power supply unit (PSU) when the other PSU has a fault condition, indicated by an amber LED.

1. After you complete the proper shut down of the application and when you are ready to power down the storage enclosure, press the power switch to the OFF position for each PSU.
2. Disconnect each power connector from its PSU socket or from the PDU.
3. You must wait a minimum of 15 seconds before power cycling the PSU and a minimum of 30 seconds after successful completion of the power on sequence before you attempt to place the PSU in standby or remove power again.

Interpret system LEDs

Visual cues provide you with the means to monitor the storage enclosure and its components and reinforce software messages about system health. Use LEDs throughout the storage enclosure to determine if there is a critical fault.

The storage enclosure registers the following states using the identified LED colors.

1. **Green or unlit LED:** Indicates a module is functioning normally
2. **Flashing green or amber LED:** Indicates a non-critical condition
3. **Amber LED:** Indicates a critical fault
4. **Blue LED:** Indicates system component identification, so is not a fault or critical condition

Since an amber fault LED uses fast or slow flashes to cover multiple conditions, this is the priority for simultaneous indications:

Table 3 Fault LED prioritization

Priority	Flash rate	Indication	Description
Top priority	Fast flash (1s on, 1s off)	Identify	Locate the enclosure or module
Priority 2	On	Fault	Fault condition detected
Priority 3	Slow flash (3s on, 1s off)	Logical or non-critical fault	Logical fault or non-critical notification
Lowest priority	Off	No indication	System functioning normally

The front panel area and controller module LEDs require further elaboration.

Interpret 5U enclosure operator's panel LEDs

The storage enclosure operator's (ops) panel contains a series of LEDs to reflect system status. You can monitor the ops panel LEDs to determine system status in combination with the user interface content.

In the case of a system fault condition, identified in the state column with an asterisk (*), troubleshoot the fault. See the baseboard management controller (BMC) system event log (SEL) for detailed information.



LED	Type	Color	State	Status	
02	Unit ID	Green	On	Unit identification (UID) of storage enclosure (0-99)	
			Flashing (1s on, 1s off)	SCSI enclosure services (SES) controlled UID or locate active	
✓	Power on or standby	Green	On	Storage enclosure power is on	
			Amber	On	Storage enclosure has AC power and is on standby as enclosure comes online
			None	Off	Storage enclosure AC power is off
X	Module fault	Amber	On*	Ops panel completing 5s test	
				Module fault in rear panel area, when paired with module fault LED	
				Drive fault, when paired with drive fault LED	
			Flashing*	Unknown, invalid, or mixed module types, such as mixed drive modules or PSUs	
				Vital product data (VPD) configuration error or 1°C bus fault	
			Off	Storage enclosure rear panel area modules functioning properly	
Cylinder icon	Logical status	Amber	On*	System component hardware fault: drive, cable, or fanout card	
				System component hardware change of status	
				Drive fault caused loss of redundancy	
			Flashing*	System software reports an informational condition for the array, such as a rebuild operation, with corresponding drives registering a fault	
			Off	System component hardware functioning properly, no errors	
Cube icons	Drawer 1, Drawer 2 hardware fault	Amber	On*	Upper, lower drawer hardware fault: drive, cable, or fanout card	
			Flashing (1s on, 1s off)	UID or locate active for Drawer 1, Drawer 2 sideplane or drive	
			Off	Upper, lower drawer hardware functioning properly	

Figure 20 5U84 operator's panel LEDs

Interpret drawer LED panels

Each storage enclosure drawer bezel contains 2 LED panels to reflect drawer status and activity, 1 for each sideplane. Each sideplane represents a data path within the drawer. You can monitor the drawer LED panels to determine drawer status in combination with the user interface content.

In the case of a fault condition, identified in the state column with an asterisk (*), troubleshoot the fault. If a fault exists on a single data path, only the related LED panel reports the fault, just as it would with a cable module, cable link, or drive faults. See the baseboard management controller (BMC) system event log (SEL) for detailed information.







LED	Type	Color	State	Status
	Power and sideplane OK	Green	On	Drawer power on and sideplane hardware functioning properly
			Off	Power to drawer off
	Drawer module fault	Amber	On*	Drawer module fault condition for drawer sideplane or drive
			Flashing (1s on, 1s off)	Unit identification (UID) or locate active for drawer sideplane or drive
			Off	Drawer modules functioning properly
	Logical status	Amber	On*	Drive hardware fault condition
			Flashing* (3s on, 1s off)	One or more arrays impacted by drive hardware fault conditions
			Off	Drive module hardware functioning properly
	Drawer cable fault	Amber	On*	Cable between rear panel area and drawer fault condition
			Off	Cables functioning properly
	Drawer data activity bar	Green	Flashing (1s on, 1s off)	Segments reflect amount of data activity: greater numbers of segments reflect greater data activity
			Off	No data activity

Figure 21 5U84 drawer LED panel

Interpret controller module LEDs

There are two redundant controller modules (CMs) that use a series of LEDs to reflect host connectivity status. You can monitor the LEDs from the rear panel area to determine system status in combination with the user interface content. You cannot mix controller types when daisy-chaining controllers.

In the case of a fault condition, identified in the state column with an asterisk (*), troubleshoot the fault and take appropriate corrective action.

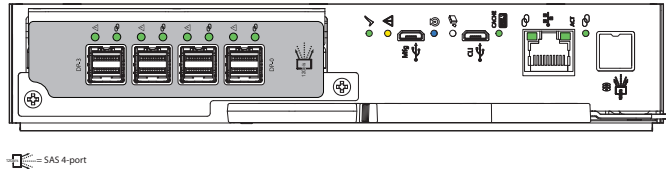

LED	Type	Color	State	Status
✓	Hardware normal	Green	On	CM functioning properly
			Flashing	Part of sequence as CM comes online, on standby
			Off	CM power is off, CM is offline, or CM has a fault condition
⚠	Hardware fault	Amber	On*	CM hardware fault
			Off	CM functioning properly
🎯	Identify	Blue	On	Unit identification (UID) active
			Off	Normal state, no query for UID active
📦	OK to remove	White	On	Ready for removal, the cache is clear
			Off	Do not remove the CM, cache still contains unwritten data
CACHE 	Cache status	Green	On	Cache contains unwritten data, CM functioning properly
			Fast flash (1s on, 1s off)	Cache is active, cache flush in progress
			Slow flash (3s on, 1s off)	Cache self-refresh in progress after cache flush
			Off	Cache is clear
			Off	System is coming online

Figure 22 Controller module LEDs applicable to all variations

Additional port LEDs on the CM relate to host connectivity and network activity, depending on the controller type.

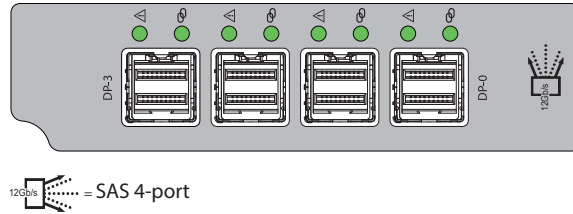

Protocol	LED	Description	Color	State	Status
		4-port 12Gb/s SAS link activity	Green	On	Connected, link is up
			Green or amber	Flashing	Link activity
			Amber	On	Connected, partial link is up
			None	Off	Not connected or link is down
		Ethernet network port speed	Amber	On	1000base-T negotiated rate
				Off	10/100base-T negotiated rate
	ACT	Ethernet network port link activity	Green	On	Ethernet link is up
				Off	Ethernet link is down
		SAS expansion port status	None	Not supported	

Figure 23 Port LEDs for SAS controller modules

6 Storage enclosure management

Select a method for accessing the controller module (CM), based on your own system requirements or the requirements of your customers.

Table 4 Methods of access to controller module

Type	Description
Local serial port connection and a terminal emulator	Local access to CM using serial port input and output
Serial over LAN (SOL)	Remote access to CM redirected serial port input and output to network
Console redirection (iKVM)	Local access to CM using a keyboard, video or monitor, and mouse

Select an interface that best fits your requirements to directly or remotely monitor and manage storage enclosure activity.

Table 5 Interface options

Method	Description
Command-line interface (CLI)*	Supports interactive and scripted commands
Storage Management Console (SMC)*	Provides web-based GUI
JSON-based Application Programming Interface (API)	Provides means to conduct JSON-based operations
Redfish/Swordfish-based API	Provides means to conduct Redfish/Swordfish operations
XML-based API	Provides means to conduct XML-based operations

*Access method discussed in the following content

TIP Use the QR code in "Product documentation and support" on page 8 to access related documentation online.

Command-line interface usage

One of the simplest methods of monitoring and managing activities performed by the storage enclosure system is to use the command-line interface (CLI). There are two primary access methods:

- Direct connection to the serial USB port of the using a terminal emulator installed on a management host
- Remote connection to a secure LAN using either SSH or HTTPS

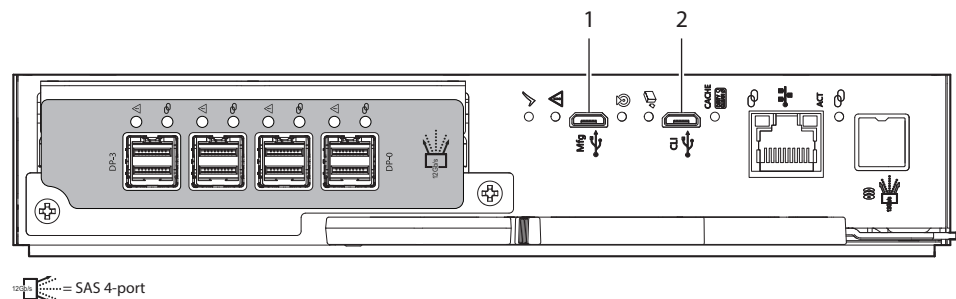

Item	Description
1	Manufacturing USB port: Do not use
2	Serial USB port for use with supplied serial cable

Figure 24 USB ports on sample SAS 4-port controller module

All setup and configuration tasks identified in this section assume you have a direct connection between the management host and the controller using the supplied or a tested, good serial cable. The connection you establish is an out-of-band connection, since it does not use a data path to transfer information between the controller and the management host. The host computer or server can be either Linux- or Windows-based. Certain operating systems require a special mode of operation or the installation of a device driver.

Install a device driver

Some operating systems, such as a Windows OS that predates Windows 10/Server 2016, require download and installation of a device driver before the OS recognizes the USB device and can connect to a controller module.

To install a device driver:

1. Navigate to <https://www.seagate.com/support/systems/general-support/> and locate the device driver for download.
2. Download the zip file to the management computer.
3. Unzip the file, then run `Setup.exe`.
4. Follow all install instruction dialogs, selecting the prompts to run, accept, and install the device driver.
5. After successful completion of the install, close the dialog.
6. (Optional) Reset the management computer if required to complete installation and recognize the device driver.

Configure the management host for serial communication

After you successfully connect the supplied serial cable to the controller module (CM), the management host should detect a new USB device. The next step is to establish communication between the management host and the CM.

Once you successfully install and run a supported terminal emulator, the controller presents a single serial port that uses the related USB vendor identification (ID) and product ID hex codes.

Table 6 Supported terminal emulator applications

Operating system	Supported application
Microsoft Windows (all versions)	HyperTerminal, TeraTerm, PuTTY
Linux (all versions)	Minicom

Table 7 Terminal emulator serial port hex codes

USB vendor identification code type	Hex code
USB vendor identification code	0x210C
USB product identification code	0xA4A7

Configure Linux for serial communication

If you do not have a terminal emulator, such as Minicom, you must obtain one prior to completion of this task.

ⓘ IMPORTANT While a Linux system may not require installation of a device driver, it might require USB parameters as you load the device driver to enable controller recognition.

```
modprobe usbserial vendor=0x210c product=0xa4a7 use_acm=1
```

You may also choose to incorporate the same information into the `/etc/modules.conf` file.

To configure Linux for serial communication:

1. Determine if the operating system recognizes the USB (ACM) device by entering a command:

```
cat /proc/devices |grep -i "ttyACM"
```

If the OS discovers a device driver, it responds with the device number followed by `ttyACM`, for example:

```
116 ttyACM
```

2. To query the system about USB buses and the devices connected to them, use the `lsusb` command:

```
lsusb
```

If the OS discovers a USB device driver, it responds with the single serial port using the USB parameter hex codes, for example:

```
ID 210c:a4a7
```

This confirms that the appropriate USB (ACM) device is visible to the management computer.

3. Invoke `Minicom` to configure it.

```
minicom -s
```

4. Select `Serial Port Setup` from the menu.
5. Select the parameter setting you want to change at the prompt by typing the related setting letter (A-G).

Table 8 Sample Linux Minicom serial port parameter settings

Setting	Description	Parameter settings
A	Serial device	/dev/ttyACM0
B	Lockfile location	/var/lock
C	Callin program	
D	Callout program	
E	Bps/Par/Bits	11520 8N1
F	Hardware flow control	No
G	Software flow control	No

6. Press the `ESC` key to shift from the parameters to the configuration menu.
7. Select `Save setup as dfl` to save the parameter settings to default.
8. Select `Exit` from `Minicom`.

Configure Windows for serial communication

Use the terminal emulator to launch the device driver window and directly communicate with each controller module, after meeting the following prerequisites:

- An installed and tested terminal emulator.
- An installed and tested Windows USB device driver to connect to the controller module USB port, by using the native USB serial driver for Windows 10/Server 2016 or higher, or by downloading and installing the Seagate device driver.

To configure Windows for serial communication:

1. Start and configure the terminal emulator, using the specified settings.

Table 9 Terminal emulator port connection settings

Parameter	Value	Parameter	Value
Connector	COM3 ¹	Parity	None
Baud rate	115,200	Stop bits	1
Data bits	8	Flow control	None

¹ Your configuration determines the COM port used for USB connection. Verify you have the correct COM port.

2. In the terminal emulator, right-click on the connected and identified COM port and select **Enable**.

NOTE You must change the Flow Control selection to NONE when using Windows 10/Server 2016 with PuTTY. Then you can open the COM port.

3. For a connection that stops responding, take the following corrective actions:
 - a. Validate the terminal emulator configuration is correct and you selected the correct COM port.
 - b. Quit the terminal emulator program.
 - c. In the Windows Device Manager window, right-click on the problem COM port and select **Disable**.
 - d. Confirm the COM port disabled status.
 - e. Right-click on COM port you just disabled and select **Enable** to re-enable it.
 - f. Start the terminal emulator program again and connect to the COM port, then validate the port settings again.

Connect to a controller module for configuration

When you first install a storage enclosure, you must perform some initial tasks to connect to and configure the system, such as setting up a user, log in, and setting a valid IP address for each controller module (CM) serial COM port.

You have 3 options for setting up a network, each a viable approach to the same goal: connection to the CM.

- Use a direct connection to the serial COM port to access the Storage Management Console (SMC).
- Use a remotely connected network to access the SMC and connect to the CM through the identified factory default IP addresses.
- Use secure shell (SSH) to access the SMC at the identified factory default IP addresses.

> `ssh 10.0.0.2`

If the CM default IP address is not compatible with your network, you must manually set a valid IP address for each network port, once you have a good serial port connection to the management host.

Table 10 Factory default network port IP addresses

IP version	Controller OA addresses		Controller OB addresses	
IPv4	IP address:	10.0.0.2	IP address:	10.0.0.3
	IP subnet mask:	255.255.255.0	IP subnet mask:	255.255.255.0
	Gateway IP address:	10.0.0.1	Gateway IP address:	10.0.0.1

Table 10 Factory default network port IP addresses (continued)

IP version	Controller OA addresses		Controller OB addresses	
IPv6	Autoconfig:	Enabled	Autoconfig:	Enabled
	Gateway:	::	Gateway:	::
	Link-Local Address:	fe80::2c0:ffff:fe44:952f	Link-Local Address:	fe80::2c0:ffff:fe44:7010
	Autoconfig IP:	6::2c0:ffff:fe44:952f	Autoconfig IP:	6::2c0:ffff:fe44:7017

To connect to a controller module for configuration:

1. Connect a serial cable from your management host to the CLI port on one of the CMs.
2. Launch the terminal emulator software and enable the CLI port for subsequent communication.
3. Press **Enter** to access the CLI prompt.
4. At the prompt, login with **setup**, press **Enter**, then press **Enter** again at the password prompt, for example:

```
System Version: S100R009
OS Version: SPM100R009-01
MC Version: SXM100R009-01
Serial Number: 00C0FF535A86
SEAGATE00C0FF527EB8B login: setup
Password:
```

5. For first time access to the SMC, enter **Y** at the prompt to continue.
6. To log in at the prompt, choose from one of the following actions:
 - a. For first time access, create a user, such as **manage**, and follow the on-screen directions to create a user account. After doing so, the session will expire, and you can log in as the user you just created.
 - b. For all subsequent log in activity, log in using valid system user credentials.
7. At the prompt, type the following command to set the IP address for each controller module or both controller modules:

```
set network-parameters ip <address> netmask <netmask> gateway <gateway> controller a|b
```

where:

- <address> is the IP address of the controller
- <netmask> is the subnet mask
- <gateway> is the IP address of the subnet router
- a|b specifies the controller whose network parameters you are setting

For an IPv4 static example:

```
# set network-parameters ip 192.168.0.10 netmask 255.255.255.0 gateway 192.168.0.1 controller a
# set network-parameters ip 192.168.0.11 netmask 255.255.255.0 gateway 192.168.0.1 controller b
```

For a DHCP example:

```
# set network-parameters dhcp controller a
# set network-parameters dhcp controller b
```

NOTE See the CLI Reference Guide for information about IPv6, and the commands used to add IPv6 addresses and set IPv6 network parameters. The **ipv6** term is included within each relevant command name.

8. Choose one of the following actions to verify the new IP address:

- a. For IPv4, use the **show network-parameters** command.
- b. For IPv6, use the **show ipv6-network-parameters** command.

The result for each controller includes the IP address, subnet mask, and gateway address.

9. In the host computer's command window, first ping controller 0A and then controller 0B to verify connectivity.

```
ping <controller-IP-address>
```

10. When you are done using the CLI, exit the terminal emulator.

11. Retain the new IP addresses to access and manage the controllers by using either the SMC or the CLI.

If you cannot access your system after changing the IP address and waiting up to 2 or 3 minutes, your network might require you to restart each affected Management Controller (MC) connected to the serial port. When you restart an MC, you temporarily lose communication with the MC until it successfully returns to a ready state.

12. (Optional) To restart the management controller on both controllers, type the following command :

```
restart mc both
```

If you lose communication with the CLI while using an out-of-band cable connection, you can often restore communication by disconnecting and reattaching the serial cable.

After you initially set a controller IP address and have a functioning connection, you can change it later using the SMC.

! **IMPORTANT** Changing IP settings can cause management hosts to lose access to the storage enclosure.

Storage Management Console usage

Seagate provides a user-friendly interface that provides the means to configure, monitor, and manage the storage system: the Storage Management Console (SMC). Access it through a supported browser, then use it to complete initial configuration of the management host, then monitor and manage the storage enclosure.

Table 11 Supported browsers

Browser	Version
Microsoft Internet Explorer	11
Mozilla Firefox	68 and newer
Google Chrome	70 and newer
Apple Safari (Mac)	11 and newer

For best results, use the following guidelines:

- Enable browser pop-up windows and set the browser to allow cookies for the related storage system IP addresses.
- For Internet Explorer, set the browser's local-intranet security option to medium or medium-low, and then add each controller's network IP address as a trusted site.

NOTE By default, your system is loaded with self-signed certificates. You should generate new self-signed certificates on each controller, using the `create certificate` CLI command. Expect browser warnings about security or privacy concerns related to self-signed or untrusted certificates or invalid certificate authorities. Bypass such warnings if you are confident of a secure connection. Depending on the browser and its settings, you can create a security exception to inhibit future related warnings, despite the continued indication of an insecure connection in the browser address bar.

Access the web-based management interface

Once you successfully complete initial installation of the storage enclosure and initial configuration of the management host, you can access the controller module's web-based management interface, the Storage Management Console (SMC). It is a user-friendly interface that provides the means to configure, monitor, and manage the storage system.

To access the web-based management interface:

1. Launch a web browser on the computer connected to the controller module.
2. Enter the IP address of the controller module's network port, either the default address of 10.0.0.2/3 or the address you just configured, then press **Enter**.
3. To log in to the SMC, perform the following actions:
 - a. In the web browser address field, type `https://<controller-IP-address>`, such as 10.1.4.33 without any leading zeros, and then press **Enter**. If a login prompt does not display, confirm you entered the correct IP address.
 - b. At the prompt, enter the user name and password you just created. See ["Connect to a controller module for configuration" on page 38](#).
 - c. Select **Log In**. If the user authentication fails, a message indicates if the system is unavailable or unable to authenticate the login.
4. Familiarize yourself with the SMC, consulting the online help topics or the Storage Management Guide.
5. To end your session, select **Log Out** from the banner, instead of simply closing the browser.

Complete the preboard and onboard process

During your initial connection, a wizard in the Storage Management Console (SMC) guides you through the first-time setup of your system: the preboard and onboard process. Follow the on-screen directions to complete your setup.

To complete the preboard and onboard process:

1. Complete the following actions to successfully complete the preboard process:
 - a. Agree at the prompt to the end-user license agreement (EULA).
 - b. Create your profile username and password for all future access.
 - c. Update the controller firmware, as required.
2. Complete the following actions to successfully complete the onboard process:
 - a. Configure your system settings: network settings, data and time, user definitions, and system notifications.
 - b. Complete the storage system configuration, choosing the key features that pertain to the storage enclosure to ensure your storage enclosure achieves optimal capacity and performance.
 - c. Provision the storage enclosure by creating hosts and host groups, then creating volumes and attaching them to hosts.
3. Continue to use the SMC to monitor and manage the storage enclosure by following instructions in the related Storage Management Guide or use the online help.

 **TIP** Use the QR code in "Product documentation and support" on page 8 to access related documentation online.

7 Hardware installation and configuration issues

The storage enclosure management interface allows for provisioning, monitoring, and managing the enclosure. It uses the storage enclosure processor (SEP) and associated monitoring and control logic, such as the SCSI Enclosure Services (SES) service, or Redfish, to assess and diagnose power, drive modules, and cooling systems. Temperature sensors throughout the enclosure and its components monitor the thermal health of the storage system. If a critical sensor value exceeds a threshold limit, you receive a system notification that requires your attention.

If you encounter any issues during installation or initial configuration, use the topics in this section to assist you in fault isolation and correction.

! **IMPORTANT** Do not use this section for configured systems already interacting with production data. For the kind of assistance you need in such cases, contact Seagate for technical support.

Address initial start-up issues

You must successfully complete the installation tasks in the identified sequence. You must use the power cords provided with the system and install interface cables that meet system requirements.

To address initial start-up issues:

1. Complete the following actions to eliminate POST issues:
 - a. For dual controller configurations, wait a minimum of 10 minutes for each controller to complete synchronization with the other controller and to reach a ready state.
 - b. For single controller configurations, wait a minimum of 2 minutes for the storage enclosure to reach a ready state.
2. Complete the following actions to eliminate power cord issues during installation:
 - a. Request a replacement for damaged or missing power cords.
 - b. Request a replacement for cords with plugs that do not match your outlets or voltage requirements
 - c. Request a replacement for power cords that are too short to reach a power distribution unit.
3. Use LEDs throughout the storage enclosure as a means to determine if there is a critical fault. See ["5U84 enclosure fault LEDs" on the next page](#).
4. Complete the following actions to verify your installation if the host system does not recognize the storage enclosure:
 - a. Verify the interface cables you connected from the storage enclosure to each host bus adapter are not damaged, loose, or wired improperly.
 - b. Look for any host connection indicators on both controller modules.
 - c. Look for drive or disk group target visibility on the host side.
 - d. Verify you correctly installed the operating system software driver.
5. Complete the following actions if the storage enclosure does not initialize:
 - a. Verify each power cord is properly and securely connected on both ends.
 - b. Reconfirm that the power source used to power the storage enclosure, is viable, and meets the installation criteria.
 - c. Power cycle the storage enclosure.
 - d. Examine the controller module system log for errors.

6. Complete the following actions if the storage enclosure does not report as much capacity as expected:
 - a. Verify you correctly installed the drive modules, and they are all latched to the baseplane connectors.
 - b. Verify all installed drive module carriers display green LEDs, rather than fault LEDs. See ["Replace a 5U enclosure drive module in its carrier"](#) on page 56, following replacement procedures for any with fault LEDs.

Interpret storage fault LEDs

Throughout the storage enclosures, steady amber LEDs indicate a fault condition, but flashing indicates a non-critical condition. Some FRUs have more than one fault condition. An asterisk (*) indicates a fault condition.

5U84 enclosure fault LEDs

Visually inspect the front panel area for fault LEDs, then locate the component fault LEDs, based on general location identified on the operator's panel or the drawer indicators. If a hardware issue prevents access to the SMC or CLI, this is the only option available. An asterisk (*) indicates a fault condition.

Operator's panel fault LEDs

The operator's (ops) panel uses several green and amber LEDs to identify various states. Use the amber fault conditions identified on the operator's (ops) panel to direct you to the fault LEDs on suspect modules. The asterisk (*) indicates a fault condition.





LED	Type	Color	State	Status
X	Module fault	Amber	On*	Ops panel completing 5s test
				Storage enclosure rear panel area module fault: CM, fan, or PSU when paired with module fault LED
				Drive fault, when paired with drive fault LED
			Flashing*	Unknown, invalid, or mixed module type, such as drive or PSU
				VPD configuration error or 1°C bus failure
Off	Storage enclosure rear panel area modules functioning properly			
Cylinder icon	Logical status	Amber	On*	System component hardware fault: drive, cable, or fanout card
				System component hardware change of status
				Drive fault caused loss of redundancy
			Flashing*	System software reports an informational condition for the array, such as a rebuild operation, with corresponding drives registering a fault condition
Off	System component hardware functioning properly			
Cube icons	Drawer 1, Drawer 2 hardware fault	Amber	On*	Upper, lower drawer hardware fault: drive, cable, or fanout card
			Flashing*	Unit ID (UID) or locate is active for Drawer 1, Drawer 2 sideplane or drive
			Off	Upper, lower drawer hardware functioning properly

Figure 25 5U84 operator's panel fault LEDs

Drawer panel fault LEDs

Each drawer contains up to 42 drive modules in their carriers (DDICs) and retains cable connections inside the enclosure chassis. Drawer panel fault LEDs register whether the failure is a hardware failure, a logical failure, or a cabling failure for that drawer or its related components. The asterisk (*) indicates a fault condition.



LED	Type	Color	State	Status
	Drawer module fault	Amber	On*	Component within drawer fault condition ¹
			Flashing*	Drive fault ¹
			Off	Drawer modules functioning properly
	Logical fault	Amber	On*	Drive hardware fault condition
			Flashing*	One or more arrays impacted by drive hardware fault conditions
			Off	Drive hardware functioning properly
	Drawer cable fault	Amber	On*	Cable from rear panel to drawer fault condition ²
			Off	Cables functioning properly

¹ If all drives are functioning properly, contact Technical Support for assistance.
² Contact Technical Support for assistance.

Figure 26 5U84 drawer fault LEDs on drawer LED panel

Drive carrier fault LED

The drive module in its carrier (DDIC) uses a single amber fault LED to identify various states. The asterisk (*) indicates a fault condition.



Color	State	Status
Amber	On*	Drive has hardware fault, replace as soon as possible
	Fast flash (1s on, 1s off)	Drive link down
	Slow flash* (3s on, 1s off)	Unit identification (UID) or locate is active for drive
		Drive in critical condition
Off	Failed array	
	No AC power present	
	Drive initialization in process	
	Drive quarantined	

Figure 27 Drive fault LED on carrier bezel

Controller module fault LEDs

The controller module (CM) has a number of ports, some with independent status LEDs. The illustration below is of the SAS four-port version of the CM. The amber LEDs listed below are the only ones that provide fault condition status. The asterisk (*) indicates a fault condition.

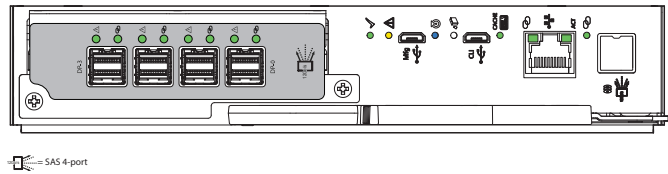



LED	Type	Color	State	Status
	SAS expansion port	Amber	Not supported	
	Hardware fault	Amber	On*	CM hardware fault
			Fast flash (1s on, 1s off)	Part of sequence as CM comes online
			Off	CM functioning properly
	OK to remove	White	On	Ready for removal, the cache is clear
			Off	Do not remove the CM, cache still contains unwritten data

Figure 28 Controller module fault LEDs

Consult your solution service documentation for details on how to minimize system disruption during service replacement of a controller module. Fault conditions include the following:

- Logs or events indicate a fault condition for the CM.
- The *Hardware fault* LED on the CM is steady or flashing amber.
- The *Hardware fault* LED for one of the four SAS 12Gb/s ports on the CM is steady or flashing amber.
- The *Module fault* LED on the storage enclosure ops panel is steady amber.
- Troubleshooting indicates a problem with the CM. When you are isolating connectivity or drive module fault conditions, stop the data flow to the affected disk groups from all hosts as a data protection precaution and perform a backup of your data.

When all of the prior LED fault conditions occur simultaneously, it is a clear indication of component failure.

Expansion module fault LEDs

The expansion module has a number of ports, some with independent status LEDs. The amber LEDs listed below are the only ones that provide fault condition status. The asterisk (*) indicates a fault condition.

Fan cooling module fault LEDs

The fan cooling module (FCM) has a green and an amber fault LED to identify various states. The asterisk (*) indicates a fault condition.

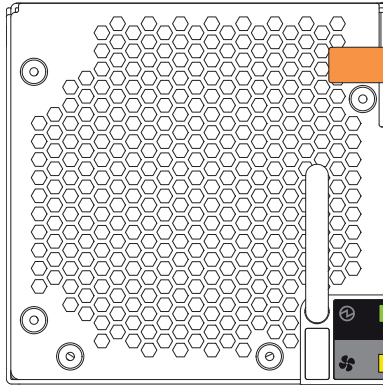

LED	Type	Color	State	Status
	FCM OK	Green	On	FCM hardware functioning properly
			Off*	FCM hardware fault
	FCM fault	Amber	On*	Fan speed is out of tolerance
			On*	Communication with controller module (CM) lost
			Off	FCM hardware functioning properly

Figure 29 Fan cooling module fault LEDs

Power supply unit fault LEDs

Each power supply unit (PSU) has three status LEDs. The asterisk (*) indicates a fault condition.

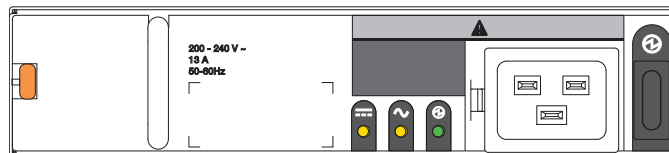

LED				Status
Type	PSU fault	AC fault	PSU OK	N/A
Color	Amber	Amber	Green	
State	Off			AC power not present
	On*		Off	PSU present, but not supplying power
	Flashing		Off	Firmware download to PSU in progress
	Off		On	AC power present, power switch is on, providing power
	Off		Flashing	AC power present, PSU on standby, other PSU providing power
	On*			Communication with controller module (CM) lost
	On*	N/A	Off	PSU hardware fault
	On*			PSU alert state or hardware fault: over temperature, over voltage, or over current
	Off	On*	Off	AC power failed, PSU not providing power, other PSU providing power
Off	On*		AC power failed, PSU running on battery	

Figure 30 Power supply unit fault LEDs

Identify 5U enclosure fault conditions

Fault conditions do not necessarily cause the storage enclosure to cease functioning. Fault conditions do require a system administrator to take an appropriate action to clear the fault condition.

The controller modules (CMs) allow you to choose from multiple fault isolation methods. This section provides the basic methodology used to locate faults within a storage system, then identify the affected FRUs.

When performing fault isolation and troubleshooting steps, select the option or options that best suit your site environment. Use of any one of the following options is not mutually exclusive to the use of another option. The order for the options is based on frequency of use.

To identify 5U enclosure fault conditions:

1. Monitor event and alert notifications through your host system interface.
 - a. **Event notifications:** The system event logs record all system events and identifies the event type and its severity.
 - b. **Alert notifications:** An alert reports a system fault, registers the type and severity, then tracks its resolution.
2. Alerts fall into three categories, listed in order of severity. Resolve them, moving from most severe to least severe.
 - a. **Critical alerts:** Such alerts require immediate resolution, since they may cause a controller module to shut down or place data at risk.
 - b. **Warnings:** Such alerts require immediate attention so you can evaluate the problem and correct it.
 - c. **Informational alerts:** Such alerts neither require immediate attention nor immediate action.
3. Use the Storage Management Console (SMC). You can use the SMC to monitor the health icons or values for the system and its components, to make sure that everything is functioning properly, or to locate a problem component.
4. Use the command line interface (CLI). If you discover a problem, review both the SMC and the CLI for any recommended actions.
5. Visually inspect front panel fault LEDs, then locate component fault LEDs, based on LED-identified general location. If a hardware issue prevents access to the SMC or CLI, it is the only option available.

Table 12 5U enclosure non-fault conditions

Symptom	Cause	Recommended Action
Operator's panel area LEDs, no fault conditions		
System power, system ID, and host connectivity LEDs with no module, logical, or drawer fault LEDs	System functioning properly	No action required.
Drawer panel LEDs, no fault conditions		
Drawer power and sideplane OK LED	System functioning properly	No action required.
Drawer data activity bar		
Drive module LEDs, no fault conditions		
Amber flashing LED: 1 second on, 1 second off	Drive unit identification (UID) bit is set	No action required.
Controller LEDs, no fault conditions		
LEDs other than: -CM amber fault LEDs -SAS port amber fault LEDs	System likely functioning properly	Often, no action required. See "Interpret controller module LEDs" on page 33.
FCM LEDs, no fault conditions		
FCM OK amber LED flashing	PCM is in standby mode	No action required.
PSU LEDs, no fault conditions		
PSU OK amber LED flashing	PCM is in standby mode	No action required.

Isolate hardware and connectivity faults

You may occasionally have to isolate a fault related to the storage enclosure hardware or related to data connections associated with the enclosure. This is particularly true with data paths because of the number of components involved along the data path and the complexity of the interactions. For example, if a host-side data error occurs, it could be caused by any of the involved hardware components. It could be on the host side, such as a faulty host bus adapter (HBA) or switch. It could be on the storage enclosure side, such as a faulty controller module (CM), cable, or connector. It also could be a failure involving more than one of these components.

Use this section to gather common installation hardware fault information and isolate the fault.

 **CAUTION** When you suspect a drive module or connection is the fault, halt all input and output operations to the disk group or groups from all hosts as a data protection precaution. Make sure your regularly scheduled backup is good and that you conduct another backup at the time of failure as an additional data protection precaution.

To isolate hardware and connectivity faults associated with the storage enclosure:

1. Make sure the storage enclosure reached a ready state after properly connecting the enclosure to the host system.
2. Complete the following actions to gather fault information:
 - a. Examine host application or operating system logs for fault identification.
 - b. Examine system logs from both CMs for errors, such as log and status output for fault identification.
 - c. Use system alerts to help narrow the fault to an area of the storage enclosure.
 - d. Visually inspect the operator's panel LEDs. A hardware fault LED indicates there is a hardware issue and a logical fault LED indicates there could be a drive or disk group issue.
 - e. Access the identified location, then look for an amber fault LED to help identify a faulty module.
 - f. If you cannot find a fault in any of the listed areas, the fault most likely lies outside the storage enclosure.
3. Isolate the fault to one of the components in the storage enclosure. There can be a significant number of components interacting to create a viable data path, each potentially creating an issue. For example, if a host-side data error occurs, it could be hardware, such as the CM or a faulty cable, or it could be the data host.
4. Proceed to the next section and take the recommended corrective action. This may mean obtaining a replacement FRU of the same type before replacing the faulty module.

Isolate system application faults

System application faults generally fall into two categories: drive and disk group faults or controller module (CM) cache faults.

In the case of a faulty CM or power loss, the system memory flushes to embedded MultiMediaCard (eMMC). During the process of writing to eMMC, only those components used in the flush process receive super-capacitor power. The system memory flush typically takes 60 seconds.

In the case of a faulty CM or a power loss, the cache memory flushes to nonvolatile memory. During the process of writing the cache to nonvolatile memory, only those components used in the flush process receive super-capacitor power while the *Cache* LED momentarily flashes. The cache memory Normalized Total Time to Flush (NTTF) typically takes less than 11 seconds.

After the flush, the system uses the remaining super-capacitor power to refresh cache memory.

To isolate system application faults:

1. If a drive or disk group is at fault, determine the cause, then take one of the following actions:
 - a. If the drive is marked as failed, then replace the drive.
 - b. If the disk group is not rebuilding, add a spare drive to alter the disk group state.
 - c. If you have a quarantined disk group, contact Technical Support.
2. If a CM fault condition occurs, discover the status of the *Hardware fault* LED and if it is on, replace the CM. If it is flashing, wait for the CM to come online.
3. Determine the cause of a SAS port host-side or CM-side connection fault.
 - a. Halt all input and output from the host to the storage enclosure.
 - b. Verify there is no activity on the SAS host port activity LED for that data port. If there is, halt all applications that access the storage enclosure.
 - c. Confirm the *Cache* LED is off, indicating there is no cached, unwritten data.
 - d. Reseat the host cable after inspecting it for damage to the cable and connectors.
 - e. After reconnection, if the fault condition persists, move the host cable to a port with a tested, good link status to isolate the issue to the external data path or the CM data port.
 - f. After reseating the host cable, if the fault condition persists, replace the host cable with a tested, good one.
 - g. Verify that the host bus adapter (HBA) is fully seated and the PCI slot is powered on and functioning.
 - h. If the fault condition persists, reseat the HBA.
 - i. If the SAS host port activity LED still flashes amber, replace the HBA and reconnect the cable.
 - j. If the fault condition persists, replace the CM.
4. For still unaddressed issues, proceed to the next section and take the recommended corrective action, based on the symptom. This may mean obtaining a replacement FRU of the same type before replacing the faulty module.

Take corrective action for 5U enclosures

After you follow the process above and isolate the fault to an area of the storage enclosure or to a particular module, use the following chart to determine the type of corrective action you should take.

Table 13 5U enclosure corrective action for fault conditions









Symptom	Cause	Recommended action
Operator's (ops) panel fault LED for logical faults		
<p>Logical fault LED is on</p> 	A fault condition related to the system application logic	<ol style="list-style-type: none"> 1. Scan the enclosure event log for specific information for the fault. 2. For system application faults, see Isolate system application faults. 3. If the above actions do not resolve the fault, isolate the fault to the failing component identified in the rear panel area and follow the instructions below.
<p>Module fault LED is on</p>  <p>and Drawer logical fault LED is on</p> 	A fault condition related to the hardware or system application logic	<ol style="list-style-type: none"> 1. Inspect the drawer panel for a fault amber LED that is on. 2. Inspect the LEDs on the carriers in the drawer for these conditions: <ul style="list-style-type: none"> • The carrier LED is off. • The carrier fault amber LED is on, not flashing. 3. Select one of the following actions: <ul style="list-style-type: none"> • If the carrier LED is off, verify that the carrier is fully inserted, the latch is fully engaged, and the storage enclosure is powered on. • If the fault LED is on, narrow the fault to the drive module, a connection, or both. 4. Inspect the LEDs on the drawer sideplanes. If a sideplane fault condition exists, contact your support representative. 5. Scan the enclosure event log for specific fault information and follow recommended actions. 6. If the above actions do not resolve the fault, replace the faulty drive module or carrier as soon as you have a replacement.
Ops panel fault LEDs for hardware faults		
<p>Module fault LED is on</p>  <p>and Drawer module fault LED is on</p>  <p>and carrier LED is on</p> 	A fault condition related to the hardware in the related drawer	<ol style="list-style-type: none"> 1. Inspect the drawer panel for a fault amber LED that is on. 2. Inspect the LEDs on the carriers in the drawer for these conditions: <ul style="list-style-type: none"> • The carrier LED is off. • The carrier fault amber LED is on, not flashing. 3. Select one of the following actions: <ul style="list-style-type: none"> • If the carrier LED is off, verify that the carrier is fully inserted, the latch is fully engaged, and the storage enclosure is powered on. • If the fault LED is on, narrow the fault to the drive module, a connection, or both. 4. Scan the enclosure event log for specific fault information and follow recommended actions. 5. If the above actions do not resolve the fault, replace the faulty drive module or carrier as soon as you have a replacement.
<p>Module fault LED is on</p>  <p>and Logical fault LED is on</p>  <p>and carrier LED is on</p> 	A fault condition related to the hardware in the related drawer	<ol style="list-style-type: none"> 1. Inspect the drawer panel for a fault amber LED that is on. 2. Inspect the LEDs on the carriers in the drawer for these conditions: <ul style="list-style-type: none"> • The carrier LED is off. • The carrier fault amber LED is on, not flashing. 3. Select one of the following actions: <ul style="list-style-type: none"> • If the carrier LED is off, verify that the carrier is fully inserted, the latch is fully engaged, and the storage enclosure is powered on. • If the fault LED is on, narrow the fault to the drive module, a connection, or both. 4. Scan the enclosure event log for specific fault information and follow recommended actions. 5. If the above actions do not resolve the fault, replace the faulty drive module or carrier as soon as you have a replacement.

Table 13 5U enclosure corrective action for fault conditions (continued)















Symptom	Cause	Recommended action
<p>Drawer 1 fault or Drawer 2 fault LED is on</p>  -or-  <p>and Cable fault LED is on</p> 	<p>A fault condition related to the cabling to the related drawer</p>	<p>The cabling between the drawer and the midplane failed. Contact your vendor for assistance.</p>
<p>Ops panel fault LEDs that identify rear panel area faults</p>		
<p>Module fault LED is on</p>  <p>and a controller module (CM) fault LED is on</p>  -or- 	<p>A fault condition related to the hardware in the rear panel area</p>	<ol style="list-style-type: none"> Restart the CM with a CLI or WBI command. Confirm the redundant CM is properly functioning. Select one of the following actions: <ul style="list-style-type: none"> If both have fault conditions, follow shut down instructions and power off the system enclosure by removing power to both PSUs. Do not power on until after you successfully replace both CMs. If one CM is failing, remove power, wait 1 minute, then reset the CM. If the CM still has a fault, and the failure is related to a CM host port, follow the steps associated with system application faults below. If the CM still has a fault, remove the power cord, wait 1 minute, then reseal the CM. If the CM still has a fault, replace it within the specified 8 minutes with a new one. If installing a new CM that still has a fault, remove it, inspect connections for bent pins, reinstall it, then check the event log for errors.
<p>Module fault LED is on</p>  <p>and a fan cooling module (FCM) fault LED is on</p> 	<p>A fault condition related to the system fan</p>	<ol style="list-style-type: none"> Select one of the following actions: <ul style="list-style-type: none"> For instances where both FCM fault LEDs are on, see the <i>Thermal Monitoring</i> section of this table. If only one fan is failing, remove the FCM, wait 1 minute, then reseal. If the FCM is still failing, replace it within the specified 10 minutes.
<p>Module fault LED is on</p>  <p>and a PSU fault LED is on</p>  -or- 	<p>A fault condition related to the PSU, such as a power fault condition</p>	<ol style="list-style-type: none"> Verify AC mains connections to the PSU are live. Confirm the redundant PSU is properly functioning. Select one of the following actions: <ul style="list-style-type: none"> If both are failing, follow shut down instructions and power off the system enclosure by removing power to both PSUs. Do not power on until after you successfully replace them both. If only one PSU is failing, remove the power cord, wait 1 minute, then reseal the power cord. If the PSU is still failing, remove it, wait 1 minute, then reseal it. If the PSU is still failing, replace it within the specified 6 minutes. If the power fault condition persists, contact Seagate for support.
<p>Thermal monitoring and control</p>		

Table 13 5U enclosure corrective action for fault conditions (continued)

Symptom	Cause	Recommended action
<p>Module fault LED is on</p>  <p>and a PSU fault LED is on</p>  <p>-or-</p> 	<p>Internal temperature exceeds the present threshold for the storage enclosure</p>	<ol style="list-style-type: none"> 1. Confirm you have met ambient temperature requirements identified in the Environmental Requirements section and that the air flow moves from the front to the rear of the storage enclosure. 2. Confirm you fully closed both main bay and auxiliary bay covers so latches fully engage. 3. Determine if one of the PCMs failed or is in the process of failing. Verify all fans are running at a similar RPM. If the impellers of a fan turn more than 2K RPM slower than the other fan, replace the PCM. 4. Follow instructions related to increases in fan speed, identified below. 5. Shut down the storage enclosure and investigate before continuing.
<p>Increased fan speed is greater than 12K RPM when the ambient temperature is below 23°C (73.4°F). Factors such as ambient temperature, number of installed drives, and altitude each influence fan speed.</p>	<p>Increases in fan speed are associated with reaching a thermal threshold as the first stage of the thermal control process. If you encounter fan speeds greater than 12K RPM when the ambient temperature is below 23°C (73.4°F), the likely cause is reduced airflow through the system.</p>	<ol style="list-style-type: none"> 1. Confirm all hardware is properly installed, all drives are level and latched, and both drawers are fully closed and latched. Recommendation: Visually inspect hardware during installation or replacement to fully engage or secure it. 2. Look for airflow restrictions at the front and rear of the storage enclosure. Recommendation: If a rack door blocks airflow by more than 60%, make sure it has a front minimum gap of 75mm (3 in) and a rear minimum gap of 152mm (6 in). 3. Confirm there are no restrictions based on contaminants, such as dust. Recommendation: Improve removal of contaminants and keep area clean. 4. Look for excessive re-circulation of heated air from the rear to the front of the storage enclosure. Recommendation: Avoid mounting in rack cabinets that are fully enclosed. 5. Verify temperature is within product specifications. See Standards and regulations. Recommendation: Reduce the ambient temperature in the room.

8 In-service field maintenance for 5U enclosures

You may service the identified storage enclosure FRUs and still maintain continuous operation during the replacement, but with two very important qualifiers:

- You must determine whether your system allows for continuous operation during service replacement of the storage enclosure drive modules in their carriers (DDICs) without interrupting access to enclosure file systems.
- You must complete the replacement in the allotted time, replacing only one FRU at a time. The storage enclosure design provides for redundancy, so the loss of a single FRU does not impact functionality for a limited time.

The tasks identified in this chapter first cover FRUs in the drawers, followed by FRUs accessible from the rear panel area. It is essential you adhere to all safety precautions when servicing storage enclosure FRUs.

⚠ CAUTION When performing maintenance on the storage enclosure or its components:

- Observe the caution label affixed to each drive module or FRU prior to handling or replacing it.
- Do not remove a defective FRU until you have its functional replacement ready for insertion.

To adhere to safety precautions when replacing a FRU in a storage enclosure:

1. Replace any defective FRU with a fully operational one as soon as possible.
2. Replace any defective FRU within the identified replacement time to minimize air loss and maintain optimum cooling within the storage enclosure.

Table 14 5U enclosure time limits for FRU replacement

Defective FRU	Replacement time limit
Drawers	
Drive, LFF or SFF, in carrier (DDIC)	7 minutes, including drawer closure
Rear panel area	
Fan cooling module (FCM)	7 minutes
Power supply unit (PSU)	7 minutes
Controller module (CM)	7 minutes
Attachments	
Rackmount rail kit	N/A
Cable kits: Standard HD mini-SAS to HD mini-SAS (SF-8644)	N/A
AC power cord, compatible	N/A

3. Prevent electrostatic discharge from damaging the storage enclosure or its components.
 - a. Keep a static-protected work surface clear of clutter, including plastic, vinyl, and foam.
 - b. Transport and store FRUs in static-safe containers.
 - c. Keep FRUs in their containers until reaching a clear, static-protected work surface.
 - d. Always wear a grounded ESD wrist strap that meets a minimum 1 megohm ($\pm 10\%$) resistance standard and that is snug against your skin.
 - e. Use heel straps, toe straps, or boot straps on both feet to ground to your conductive floor or dissipating floor mat or use a portable field service kit with a grounded, static-dissipating work mat.

- f. Use conductive field service tools.
- g. When removing a FRU, immediately place it in anti-static packaging.
- h. Avoid touching pins, leads, or circuitry.

Replace a 5U enclosure drive module in its carrier

The operator's (ops) panel registers either a logical fault or a drawer hardware fault or both. You must locate a faulty drive in its carrier (DDIC) within the related drawer by its amber fault condition LED.



Color	State	Status
Amber	On*	Drive has hardware fault, replace as soon as possible
		Drive link down
	Fast flash (1s on, 1s off)	Unit identification (UID) or locate is active for drive
	Slow flash* (3s on, 1s off)	Drive in critical condition
Failed array		
Off	Off	No AC power present
		Drive initialization in process
		Drive quarantined

Figure 31 Drive fault LED on carrier bezel

An important feature of the storage enclosure design is redundancy. The storage enclosure will maintain continuous operation during the replacement of a single DDIC, if it is within the time limit of 7 minutes, since opening a drawer to remove a DDIC significantly reduces airflow in the enclosure.

CAUTION If you remove any FRU while the storage enclosure is powered up, you must replace it with a tested, good spare within the allotted time for that FRU. If you do not replace the FRU and, when applicable, fully close the related drawer within the identified time limit, you void the product warranty and the storage enclosure might overheat, causing equipment failure and possible data loss.

CAUTION Do not remove covers from any FRU. There is a danger of electric shock inside. Return the FRU to your supplier for repair.

The steel carrier provides thermal conduction, radio frequency, electro-magnetic induction, and physical protection. For this task, treat the drive carrier and its installed drive as a single FRU.

To replace a 5U enclosure drive module in its carrier:

1. Complete the following actions to open the related drawer:
 - a. Facing the front of the storage enclosure, determine which drawer has a fault condition by the fault LEDs on the ops panel and drawer panels.



Figure 32 Operator's panel



Figure 33 Drawer panel

- b. If the anti-tamper lock is engaged, use a T20 Torx driver to unlock both drawer pull handles.
- c. Simultaneously press both drawer latches inward and hold them there while exerting even outward pressure until all three rows are visible and the drawer slide latch locks in the open position.

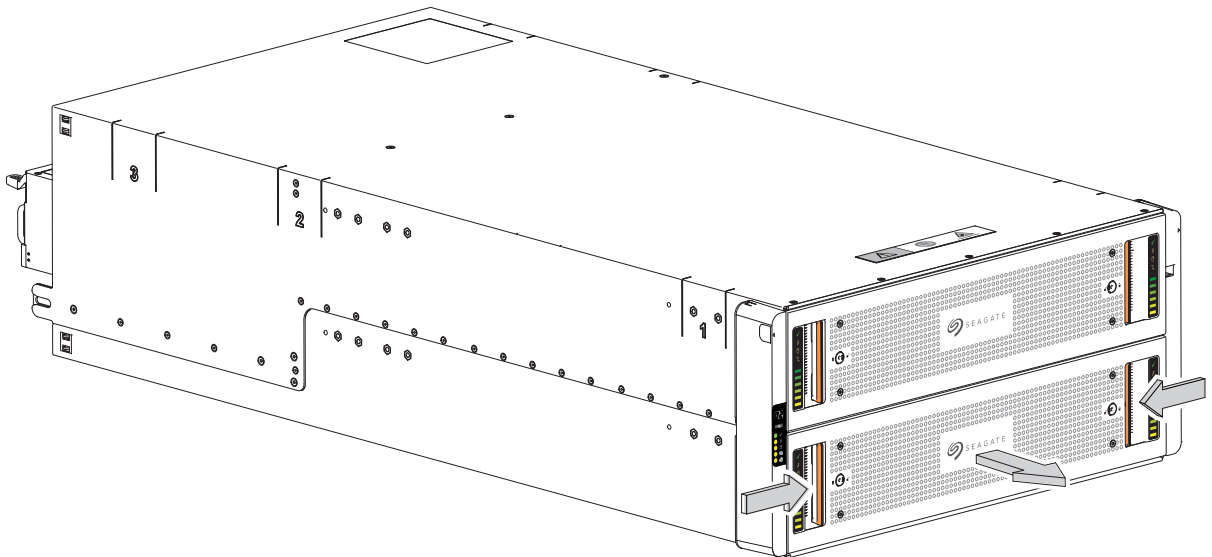

Figure 34 Drawer release and access

- d. Stop when the drawer rails engage the safety lock latches as the drawer reaches the open position, so that you can access all three rows of DDICs.
2. Complete the following actions to remove a faulty DDIC:

- a. Locate the DDIC with a fault condition.

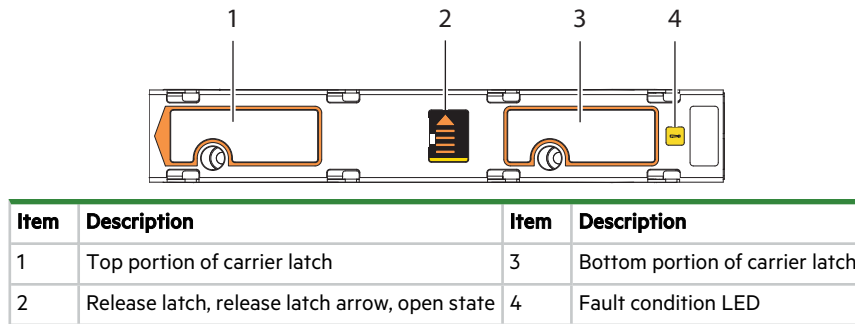

Figure 35 Carrier latch features

- b. Using a thumb, press the DDIC release latch arrow to the right to release the DDIC from its seated position.
- c. Grasping the top of the carrier, pull it upwards until it clears its drawer slot.

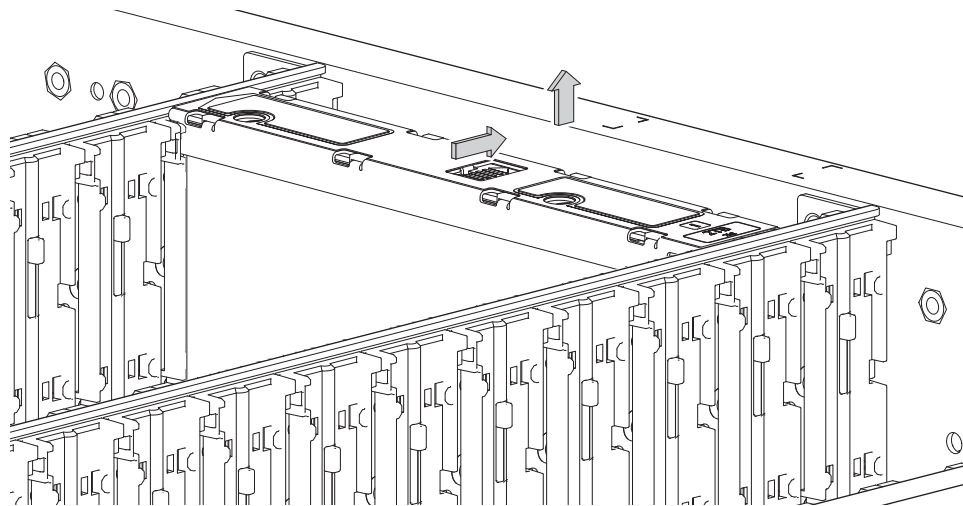

Figure 36 Removal of drive in its carrier

- d. Place it in a static-protected location.
3. Complete the following actions to replace it with a tested, good DDIC:
 - a. Select a new DDIC, orient it so the LED is towards the drawer front, and the release latch arrow towards the rear.
 - b. Align the carrier with the empty drawer slot, then lower it fully into the slot.

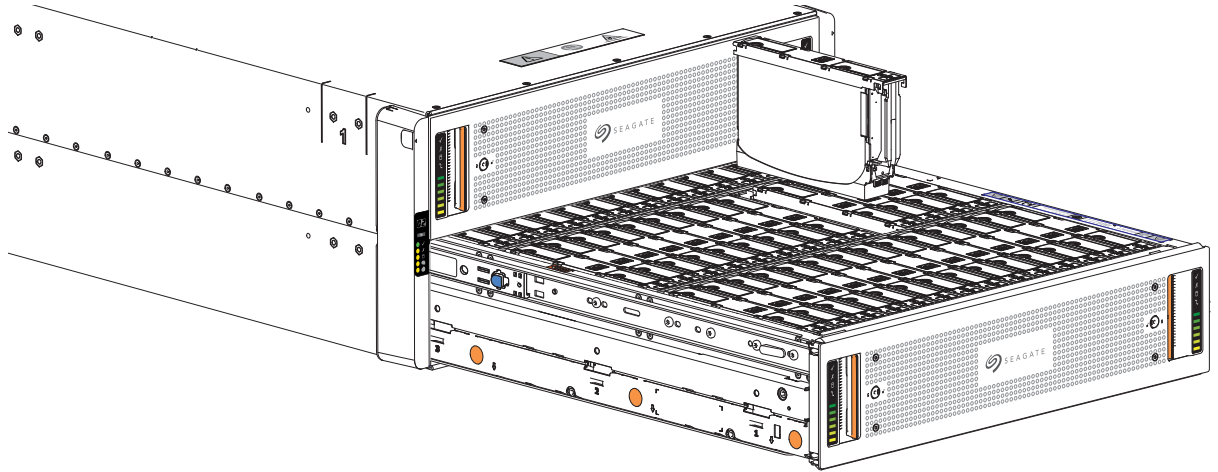

Figure 37 Replacement of drive in its carrier

- c. Push the DDIC down until the top is flush with the top of the slot.
- d. While holding it against the bottom of the slot, slide the top latch toward the rear of the drawer until it locks into place and the DDIC release latch locks.



Figure 38 Release latch open and unlocked



Figure 39 Release latch properly locked

- e. Verify that all drives are at the same level and all DDIC release latches are properly locked.

CAUTION Do not proceed to close the drawer unless all DDICs are in a fully locked position or DDIC height can inhibit or completely prevent drawer access once you close it.

- f. Confirm that the DDIC fault condition LED is off.

4. Complete the following actions to close the related drawer:
 - a. Press and hold the safety lock latches with the blue touchpoint at the front of both extended drawer slide rails.

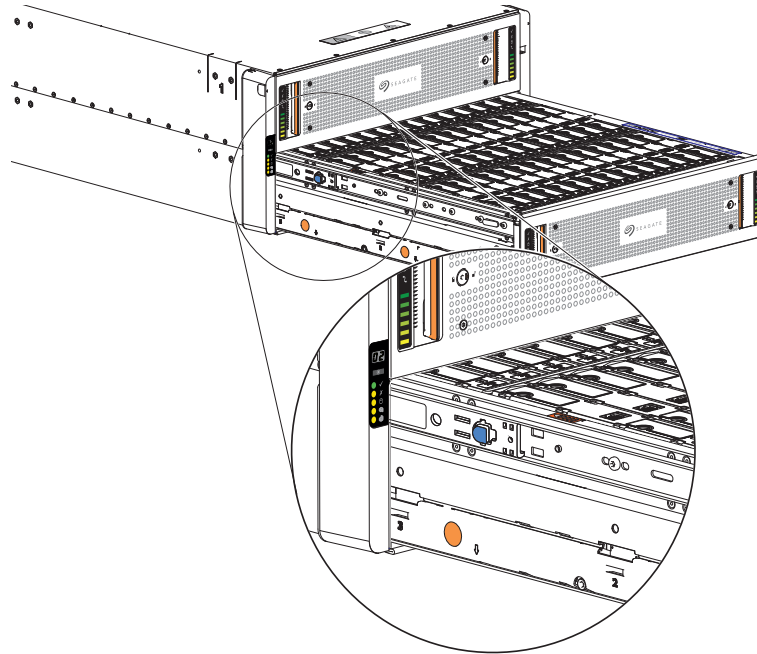

Figure 40 Safety lock to release left drawer slide rail of lower drawer

- b. Pressing simultaneously inward, begin sliding the drawer back into place until the safety lock clears the opening.
 - c. Placing the heels of both palms against the face of the drawer near the anti-tamper locks, exert even inward pressure until the drawer is almost flush with the rack ear flanges.
 - d. Simultaneously press inward and hold both drawer pull handles as you push the drawer closed until it fully latches.
5. Verify that the fault LED on the replaced DDIC is off after properly inserting and seating it in the empty slot.
6. Facing the front of the storage enclosure, verify that the *Power On* LED is green and there are no fault conditions.

Replace a 5U enclosure controller module

Both controller modules (CMs) manage the flow of data to and from the storage enclosure. Each CM provides a very specialized, solutions-specific interaction that depends on your system configuration and software implementation, including SAS zoning, failover and failback procedures, and multipath procedures.

An important feature of the storage enclosure design is redundancy. The storage enclosure will maintain continuous operation during the replacement of a single CM as long as it is within the time limit of 7 minutes, since removing a CM significantly alters airflow in the storage enclosure.

CAUTION If you remove any FRU while the storage enclosure is powered up, you must replace it with a tested good spare within the allotted time for that FRU. If you do not replace the FRU within the identified time limit, you void the product warranty and the storage enclosure might overheat, causing equipment failure and possible data loss.

CAUTION Do not remove covers from any FRU. There is a danger of electric shock inside. Return the FRU to your supplier for repair.

The CM has a number of ports, each with independent status LEDs. Those items in the state column with an asterisk (*) indicate a fault condition.

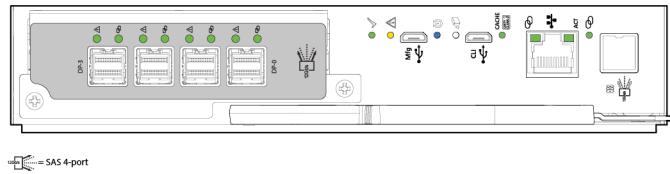



LED	Type	Color	State	Status
	SAS expansion port	Amber	Not supported	
	Hardware fault	Amber	On*	CM hardware fault
			Flashing	Part of sequence as CM comes online, on standby
			Off	CM functioning properly
	OK to remove	White	On	Ready for removal, the cache is clear
			Off	Do not remove the CM, cache still contains unwritten data

Figure 41 Controller module LEDs to examine for fault conditions

To replace a 5U enclosure controller module:

1. Complete the following actions to remove the faulty CM :
 - a. Facing the rear of the storage enclosure, carefully remove all CM connections.
 - b. Grasp the CM release latch between thumb and forefinger, then squeeze together to release the latch and handle.

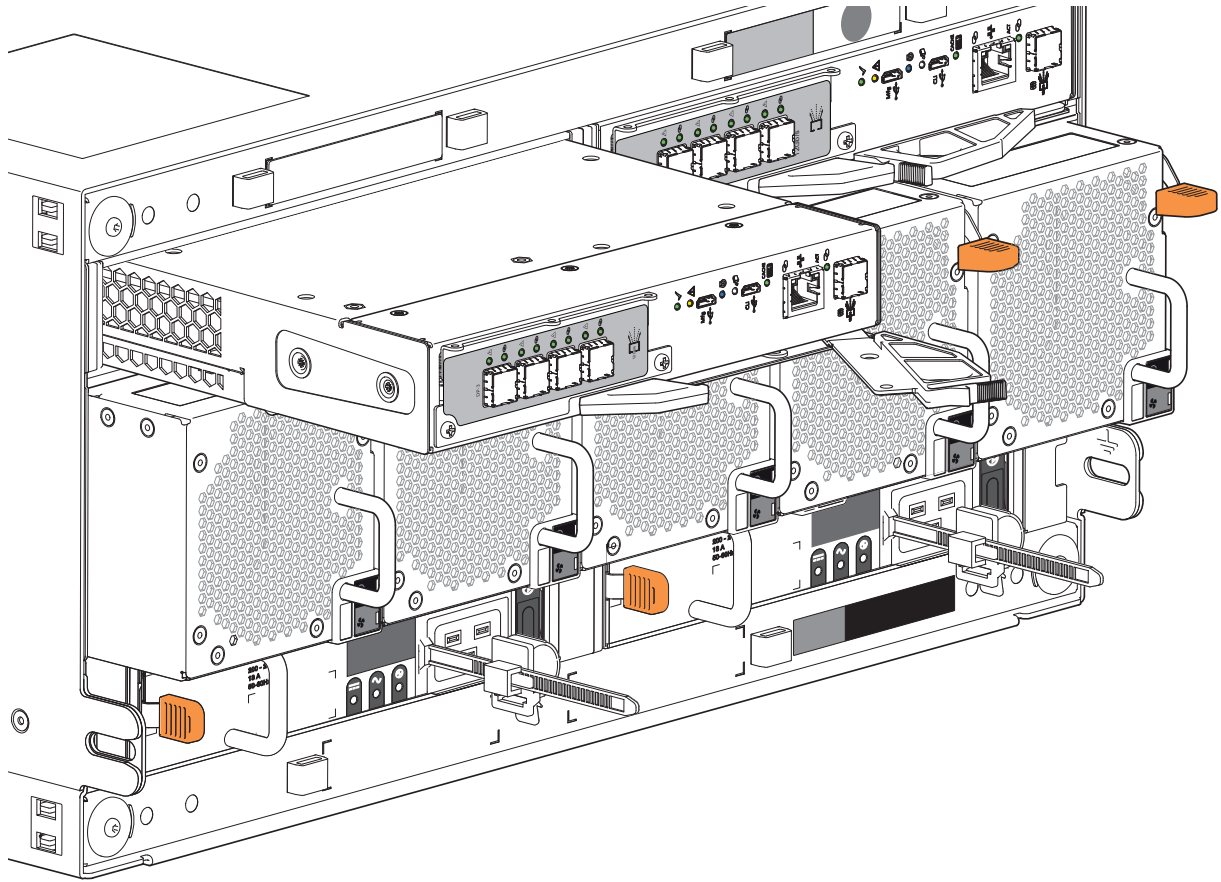

Figure 42 Controller module removal, left (SAS 4-port version)

- c. Pull the handle outward to lever the CM away from the midplane.
 - d. Use one hand to support the weight of the CM and the other to gently withdraw the CM from its slot.
 - e. Place it in a static-protected location.
2. Complete the following actions to replace it with a tested good CM:
 - a. Examine the tested good CM to make sure it is undamaged with pins that are straight, not bent.

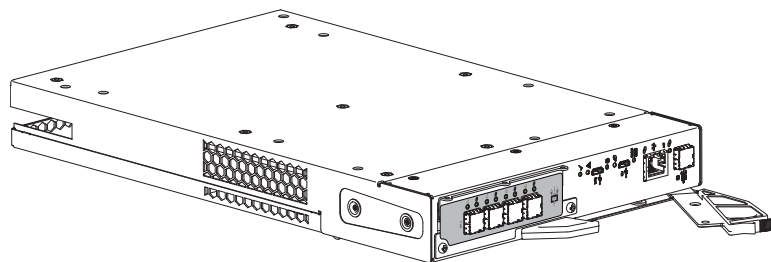

Figure 43 Replacement controller module (SAS 4-port version)

- b. Facing the rear of the storage enclosure, orient the CM with the open latch identically to the one you removed.
 - c. Use one hand to support the weight of the CM and the other to guide it into the empty CM slot.
 - d. Exerting even pressure to the center, gently press it against the midplane until the latch closes and locks in place.
3. After verifying the connectors are all undamaged, reconnect all cables as they were connected before.

4. Verify that the *Hardware normal* LED is lit green on the replaced CM after properly inserting and seating it in the empty slot.
5. Facing the front of the storage enclosure, verify that the *Power On* LED is green and there are no fault conditions.

Replace a 5U fan cooling module

Fan cooling modules (FCMs) provide cooling to storage enclosure modules and components. Each fan cooling module (FCM) has a green and an amber fault LED to identify various states. The asterisk (*) indicates a fault condition.

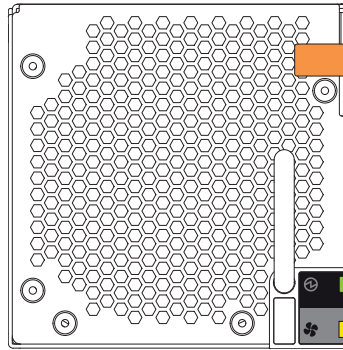



LED	Type	Color	State	Status
	FCM OK	Green	On	FCM hardware functioning properly
			Off*	FCM hardware fault
	FCM fault	Amber	On*	Fan speed is out of tolerance
			On*	Communication with AP controller module (CM) lost
			Off	FCM hardware functioning properly

Figure 44 Fan cooling module fault LEDs

An important feature of the storage enclosure design is redundancy. The storage enclosure will maintain continuous operation during the replacement of a single FCM, if it is within the time limit of 7 minutes, since removal of an FCM significantly reduces airflow in the enclosure.

CAUTION If you remove any FRU while the storage enclosure is powered up, you must replace it with a tested, good spare within the allotted time for that FRU. If you do not replace the FRU and, when applicable, fully close the related drawer within the identified time limit, you void the product warranty and the storage enclosure might overheat, causing equipment failure and possible data loss.

CAUTION Do not remove covers from any FRU. There is a danger of electric shock inside. Return the FRU to your supplier for repair.

To replace a fan cooling module:

1. Retrieve the new FCM in its static-protected container, ready to access and use the new FCM immediately upon removal of the faulty one.
2. Complete the following actions to remove the faulty FCM:

- a. Facing the rear of the rack cabinet, press downward to release the FCM latch.
- b. Use one hand to support the FCM's weight and the other to gently withdraw the FCM all the way from its slot.

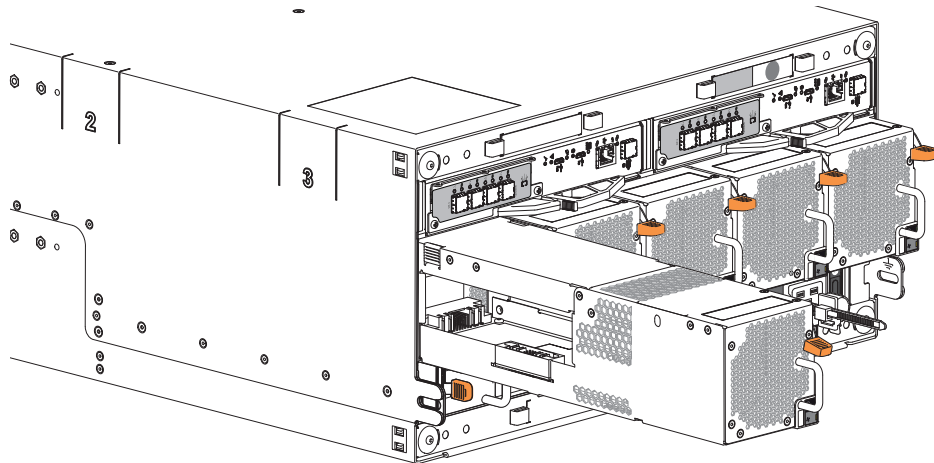

Figure 45 Fan cooling module removal

- c. Place it in a static-protected location.
3. Complete the following actions to replace the faulty FCM with a tested, good one:
 - a. Orient the new FCM with the latch to the right.

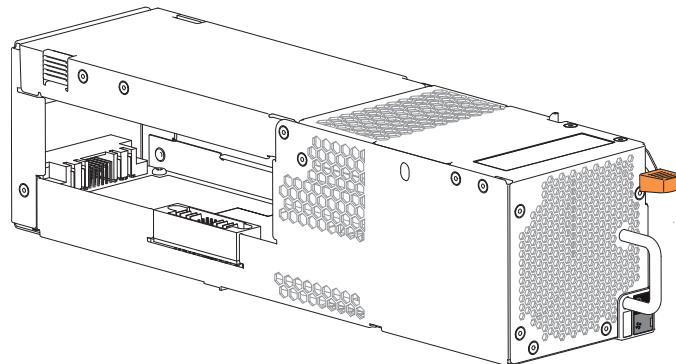

Figure 46 Replacement fan cooling module

- b. Use one hand to support the weight of the FCM and the other to guide it into the empty FCM slot.
- c. Exerting even pressure to the center, gently press inward until it connects with the midplane and it locks in place.
4. Verify the *FCM OK* LED is lit green on the replaced FCM after properly inserting and seating it in the empty slot.
5. Facing the front of the storage enclosure, verify that the *Power On* LED is green and there are no fault conditions.

Replace a 5U power supply unit

Both power supply units (PSUs) provide power to the storage enclosure within 200-240VAC at 50-60Hz.

Each PSU has three status LEDs. The asterisk (*) indicates a fault condition.

CAUTION Never remove power from a power supply unit if the partner power supply unit amber LED is lit.

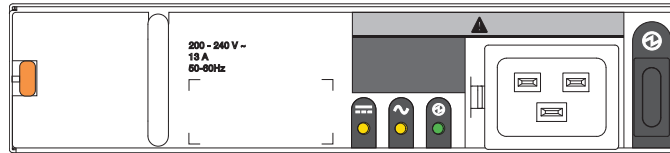

LED				Status
Type	PSU fault	AC fault	PSU OK	N/A
Color	Amber	Amber	Green	
State	Off			AC power not present
	On*		Off	PSU present, but not supplying power
	Flashing		Off	Firmware download to PSU in progress
	Off		On	AC power present, power switch is on, providing power
	Off		Flashing	AC power present, PSU on standby, other PSU providing power
	On*			Communication with AP controller module (CM) lost
	On*		N/A	PSU hardware fault
	On*		Off	PSU alert state or hardware fault: over temperature, over voltage, or over current
	Off	On*		AC power failed, PSU not providing power, other PSU providing power
	Off	On*		AC power failed, PSU running on battery

Figure 47 Power supply unit fault LEDs

An important feature of the storage enclosure design is redundancy. The enclosure will maintain continuous operation during the replacement of a single PSU, if it is within the time limit of 7 minutes, since removal of a PSU significantly reduces airflow in the storage enclosure.

CAUTION Use only power cords supplied in the installation kit or those that meet product specifications.

CAUTION Adhere to power source and power connection requirements to avoid harm to equipment.

- Only connect the power supply unit (PSU) to power sources that comply with product specifications and labels.
- Always remove all power connections before you remove a PSU from the storage enclosure.

CAUTION If you remove any FRU while the storage enclosure is powered up, you must replace it with a tested, good spare within the allotted time for that FRU. If you do not replace the FRU and, when applicable, fully close the related drawer within the identified time limit, you void the product warranty and the storage enclosure might overheat, causing equipment failure and possible data loss.

CAUTION Do not remove covers from any FRU. There is a danger of electric shock inside. Return the FRU to your supplier for repair.

To replace a power supply unit:

1. Retrieve the new PSU in its static-protected container, ready to access and use the new PSU immediately upon removal of the faulty one.

2. After you complete the proper shut down of the application and when you are ready to power down the storage enclosure, face the rear of the rack cabinet and switch off the power for the faulty PCM or PSU.
3. Disconnect each power connector from the power distribution unit (PDU).
4. Complete the following actions to remove the faulty PSU:
 - a. Release the PSU power cord from its secure tie, and then disconnect the power cord from the PSU connector.
 - b. Press the PSU release latch to the right to release the PSU from the midplane.
 - c. Use one hand to support the weight of the PSU and the other to pull the handle outward and withdraw the PSU.

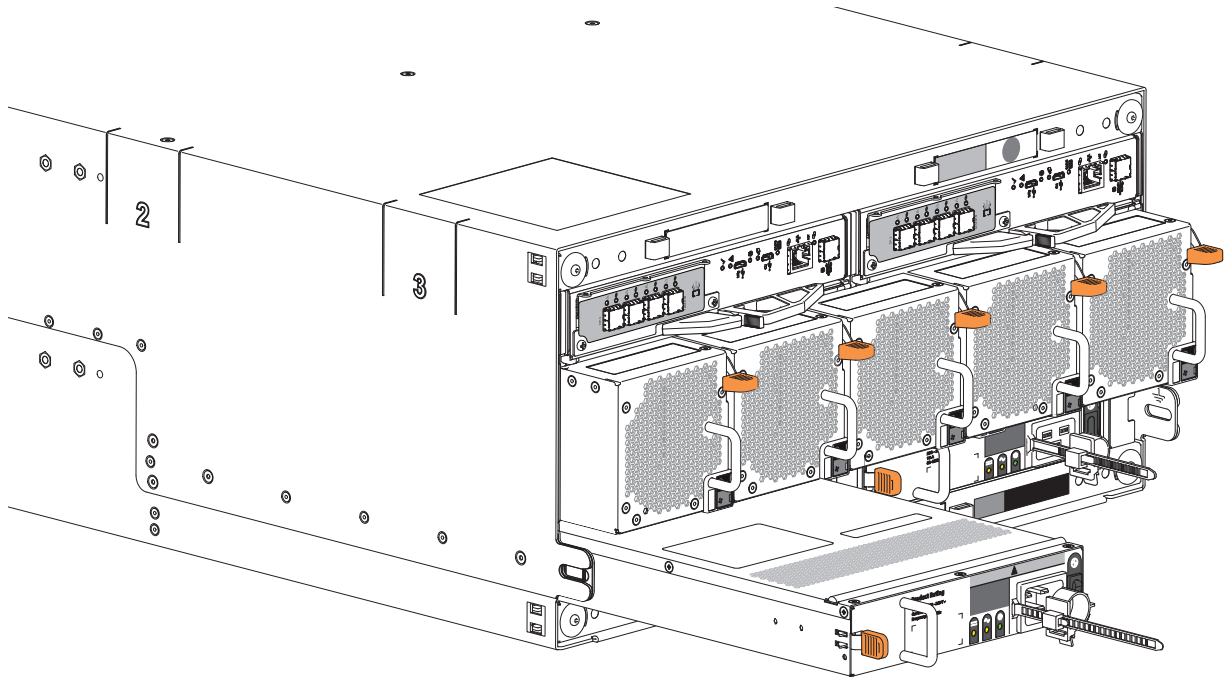

Figure 48 Power supply unit removal

- d. Place it in a static-protected location.
5. Complete the following actions to replace the faulty PSU with a tested good one:
 - a. Facing the rear of the storage enclosure, orient the new PSU with the latch to the left.

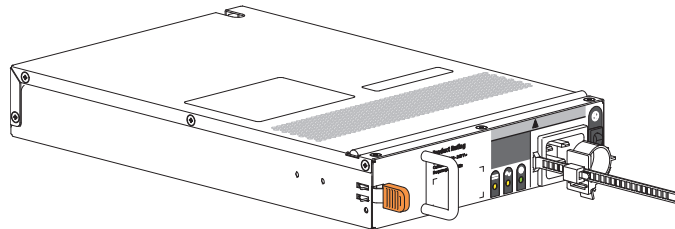

Figure 49 Replacement power supply unit

- b. Use one hand to support the weight of the PSU and the other to guide it into the empty PSU slot.
 - c. Exerting even pressure to the center, gently press inward until it connects with the midplane and it locks in place.
 - d. Connect the power cord, then move the PSU power switch to the ON position.
6. Verify that the *PSU OK* LED is lit green on the replaced PSU after properly inserting and seating it in the empty slot.

7. Facing the front of the storage enclosure, verify that the *Power On* LED is green and there are no fault conditions.

A Technical specifications

Table 15 Storage enclosure dimensions

Dimension type	5U84	
	Metric units	Imperial units
Height	220.00mm	8.65 in
Width, excluding rails	483.00mm	19.00 in
Depth, excluding cables	933.00mm	36.75 in

Table 16 Storage enclosure FRU weights

FRU or component	Metric units	Imperial units
5U84 enclosure chassis plus midplane and drawers, no FRUs or rails	36.00Kg	79.40 lb
5U84 enclosure chassis, fully populated, no rails	up to 135.00Kg	up to 298.00 lb
Drive module, either 3.5-inch LFF in carrier or 2.5-inch SFF with adapter in carrier	up to 0.80Kg	up to 1.80 lb
Controller module (CM)	up to 0.70Kg	up to 1.50 lb
5U enclosure fan cooling module (FCM)	0.80Kg	1.80 lb
5U enclosure power supply unit (PSU)	0.70Kg	1.50 lb
5U rack rails and hardware kit	8.50Kg	18.74 lb
-All weights are nominal, can vary. Unit values for drives use the heaviest drive currently qualified. -Scale calibration impacts measured weights.		

Table 17 Environmental specifications

Type	Operation	Storage, Non-operating
Temperature, ASHRAE A2	5°C to 35°C (41°F to 95°F, derated by 1°C per 300m above 900m)	-40°C to +70°C (-40°F to +158°F) Maximum temperature change in an hour: 20°C
Airflow	System must be operated with low pressure rear exhaust installation Back pressure created by rack doors and obstacles not to exceed 5 Pa (0.5mm H ₂ O)	
Altitude	-100 to 3,000 meters (-330 to 10,000 feet) Maximum operating temperature is de-rated by 1°C for each 300m above 900m (2952.76 ft)	-100 to 12,192m (-328 to 40,000 ft)
Relative humidity	-12°C dew point minimum 8% to 85% maximum, non-condensing	21°C dew point maximum 5% to 100% maximum, non-condensing
Shock	5.0 Gs, 10ms (per axis)	20.0 Gs, 10ms (X and Y axes)
Vibration	0.21Grms 5Hz to 500Hz random, 30 min per axis	1.04Grms 2Hz to 200Hz random (ISTA 3E) Relocation: ISTA3H air ride for 60 min
Acoustics	N/A	

Table 18 Power specifications

Type	Description
Input power requirements	200VAC to 240VAC, 50Hz to 60Hz
Voltage	Max output: 2200W
	Range: 200-240VAC, rated
	Frequency: 50-60Hz
Hot-swappable?	HDDs and SSDs (in chassis data slots), controller modules (CMs), fan cooling modules (FCMs), and power supply units (PSUs)

B Standards and regulations

International standards

The storage enclosure complies with the requirements of the following agencies and latest editions of these standards:

Table 19 Standard and approvals

Type	Specification	
Safety certifications	UL 60950-1; UL & cUL to UL 62368-1 2nd Ed	
	CAN/CSA-C22.2 No. 60950-1-07; No. 62368-1-14, 2nd Ed	
	CE to EN 60950-1; 62368-1	
	IEC 60950-1; 62368-1 2nd Ed (International)	
	CCC (China PRC - CCC PSUs)	
	BIS (India - BIS PSUs)	
Ecodesign	Commission Regulation (EU) 2019/424 (Directive 2009/125/EC)	
Emissions (EMC)	FCC CFR 47 Part 15 Subpart B Class A (United States)	
	ICES/NMB-003 Class A (Canada)	
	EN 55032 Class A, EN 55024, EN 61000-3-2, EN 61000-3-3 (Europe)	
	AS/NZS CISPR 32 Class A (Australia/New Zealand)	
	VCCI Class A (Japan)	
	KN 32 Class A/KN 35 (S. Korea)	
CNS 13438 Class A (Taiwan)		
Harmonics	EN 61000-3-2 (EU)	
Flicker	EN 61000-3-3 (EU)	
Immunity	EN 55024 (EU)	
	KN 24/KN 35 (S. Korea)	
Environmental standards	The RoHS Directive (2011/65/EU)	
	The WEEE Directive (2012/19/EU)	
	The REACH Directive (EC/1907/2006)	
	The Batteries Directive (2006/66/EC)	
Standard marks, approvals	North America (FCC, UL, cUL, ICES/NMB-003 Class A)	China (CCC – PSU only)
	European Union (CE)	Japan (VCCI)
	Australia/New Zealand (RCM)	Korea (KC)
		Taiwan (BSMI)

WEEE recycling

! **IMPORTANT** Observe all applicable safety precautions detailed in the preceding chapters when dismantling and disposing of this equipment.

At the end of the product's life, all scrap or waste electrical and electronic equipment, recycle it in accordance with national regulations applicable to the handling of hazardous or toxic electrical and electronic waste materials.

Contact your supplier for a copy of the Recycling Procedures applicable to your country.

Index

C

- cabling
 - cable management system 12
 - power cords meeting product specifications 14-15, 27, 65
 - route power cords 27
- command-line interface (CLI)
 - connecting USB cable to CLI port 38
- components
 - enclosure front panel (84-drive) 9
- controller module
 - LEDs 33
- corrective action 51

D

- data path
 - components 50
 - fault tolerance 9, 27
- disk groups 43, 47, 50
- drawers 24

E

- electrical guidelines 15, 26, 29, 31
- electrostatic discharge 55
- enclosure
 - cabling 26
 - dimensions 68
 - installation checklist 14
 - site requirements 14
 - troubleshooting (basic steps) 50
 - weight 68

F

- failure, hardware 50-51
 - cable, connector, or switch 50, 52-53
 - drive module 52
- fan modules 63
- fault condition 49, 52
- fault isolation 50

L

- LEDs
 - controller module LEDs 33, 49
 - drawer panel LEDs 32, 49
 - drive modules (SFF/LFF) 49
 - front panel LEDs 49
 - operators panel LEDs 31
- lift, mechanical
 - adjust height 22
 - proper approach to rack cabinet 21-22

N

- notifications
 - alerts 49
 - events 49

P

- power
 - cords 28, 43
 - prerequisites 26, 69
- power cycle 43
 - power off, power down 31
 - power on, power up 30

R

- rack cabinet 21
 - leveling 16
 - prerequisites 16
- rackmount rail system 19
 - anatomy 19
 - installation 19
 - safety guidelines 18
- replacement, in-service FRU
 - controller module 60
 - drive module or DDIC 56
 - fan cooling module (FCM) 63
 - power supply unit (PSU) 64
 - time limits 55
- return
 - FRU for repair 56, 60
 - packaging 17
 - storage enclosure 17

S

safety precautions

- electrical 26
- equipment disposal 70
- installation 21
- rack cabinet 18

sensors

- temperature 43

shipment

- original packaging damage 17
- plastic bag 17

storage enclosure

- lifting straps 18
- proper rack cabinet door clearance 16
- system airflow 9, 16, 29, 63, 68
- temperature control 9, 29, 63, 68
- total staff to install 16