

A decorative graphic on the left side of the page, featuring a large dashed circle, a solid blue circle, and several overlapping curved lines in light blue and grey.

Product Manual

SV35.2 Series® PATA

ST3750640AV

ST3500630AV

ST3320620AV

ST3250820AV

ST3160815AV

100440155
Rev. E
December 2007

Revision history

Revision	Date	Sheets affected or comments
Rev. A	10/30/06	Initial release.
Rev. B	12/18/06	9 and 17.
Rev. C	08/23/07	1.
Rev. D	09/05/07	4, 6, and 10.
Rev. E	12/19/07	11.

Copyright © 2006-2007 Seagate Technology LLC. All rights reserved. Printed in U.S.A.

Publication number: 100440155, Rev. E
December 2007

Seagate, Seagate Technology and the Wave logo are registered trademarks of Seagate Technology LLC in the United States and/or other countries. SV35 Series, SeaTools and SeaTDD are either trademarks or registered trademarks of Seagate Technology LLC or one of its affiliated companies in the United States and/or other countries. All other trademarks or registered trademarks are the property of their respective owners.

One gigabyte, or GB, equals one billion bytes when referring to hard drive capacity. Accessible capacity may vary depending on operating environment and formatting. Seagate reserves the right to change, without notice, product offerings or specifications.

Contents

1.0	Introduction	1
2.0	Drive specifications	3
2.1	Specification summary table	3
2.2	Formatted capacity	8
2.2.1	LBA mode	8
2.3	Default logical geometry	8
2.4	Recording and interface technology	9
2.5	Physical characteristics	9
2.6	Seek time	10
2.7	Start/stop times	10
2.8	Power specifications	10
2.8.1	Power consumption	10
2.8.2	Conducted noise	12
2.8.3	Voltage tolerance	12
2.8.4	Power management modes	13
2.9	Environmental specifications	14
2.9.1	Ambient temperature	14
2.9.2	Temperature gradient	14
2.9.3	Humidity	14
2.9.4	Altitude	14
2.9.5	Shock	15
2.9.6	Vibration	15
2.10	Acoustics	16
2.11	Electromagnetic immunity	16
2.12	Reliability	17
2.12.1	Annualized Failure Rate (AFR) and Mean Time Between Failures (MTBF) ..	17
2.13	Agency certification	17
2.13.1	Safety certification	17
2.13.2	Electromagnetic compatibility	17
2.13.3	FCC verification	18
2.14	Environmental protection	18
2.14.1	European Union Restriction of Hazardous Substances (RoHS)	19
2.15	Corrosive environment	19
3.0	Configuring and mounting the drive	21
3.1	Handling and static discharge precautions	21
3.2	Breather filter hole precautions	22
3.3	Jumper settings	23
3.3.1	Master/slave configuration	23
3.3.2	Cable-select option	23
3.3.3	Ultra ATA/100 cable	24
3.4	Drive mounting	24
4.0	ATA interface	27
4.1	ATA interface signals and connector pins	27
4.1.1	Supported ATA commands	28
4.1.2	Identify Device command	30
4.1.3	Set Features command	33
4.1.4	S.M.A.R.T. commands	34
5.0	Seagate Technology support services	35

List of Figures

Figure 1.	Typical 5V startup and operation current profile	12
Figure 2.	Typical 12V startup and operation current profile	12
Figure 3.	Breather filter hole location	22
Figure 4.	Master/slave jumper settings	23
Figure 5.	Ultra ATA cable connectors	24
Figure 6.	Mounting dimensions—top, side and end view	25
Figure 7.	I/O pins and supported ATA signals	27

1.0 Introduction

This manual describes the functional, mechanical and interface specifications for the following Seagate® SV35.2 Series® PATA model drives:

ST3750640AV

ST3500630AV

ST3320620AV

ST3250820AV

ST3160815AV

These drives provide the following key features:

- 7,200-RPM spindle speed
- High instantaneous (burst) data transfer rates (up to 100 Mbytes per second) using Ultra DMA mode 6.
- Tunneling Magnetoresistive (TMR) recording heads.
- State-of-the-art cache and on-the-fly error-correction algorithms.
- Full-track multiple-sector transfer capability without local processor intervention.
- Quiet operation.
- SeaTools diagnostic software performs a drive self-test that eliminates unnecessary drive returns.
- Support for S.M.A.R.T. drive monitoring and reporting.
- Support for Read Multiple and Write Multiple commands.
- Support for autodetection of master/slave drives that use cable select (CSEL).

2.0 Drive specifications

Unless otherwise noted, all specifications are measured under ambient conditions, at 25°C, and nominal power. For convenience, the phrases *the drive* and *this drive* are used throughout this manual to indicate the following drive models:

ST3750640AV

ST3500630AV

ST3320620AV

ST3250820AV

ST3160815AV

2.1 Specification summary table

The specifications listed in the table below are for quick reference. For details on specification measurement or definition, see the appropriate section of this manual.

Table 1: Drive specifications summary for 750 and 500 Gbyte models

Drive specification	ST3750640AV	ST3500630AV
Formatted capacity (512 bytes/sector)*	750 Gbytes	500 Gbytes
Guaranteed sectors	1,465,149,168	976,773,168
Heads	8	6
Discs	4	3
Bytes per sector	512	
Default sectors per track	63	
Default read/write heads	16	
Default cylinders	16,383	
Recording density	926 kbits/in max	813 kbits/in max
Track density	145 ktracks/in avg	
Areal density	128.2 Gbits/in ² avg	114.4 Gbits/in ² avg
Spindle speed	7,200 RPM	
Internal data transfer rate	1,030 Mbits/sec max	
Sustained data transfer rate OD	78 Mbytes/sec max	72 Mbytes/sec max
I/O data-transfer rate	100 Mbytes/sec max	
ATA data-transfer modes supported	PIO modes 0–4 Multiword DMA modes 0–2 Ultra DMA modes 0–6	
Cache buffer	16 Mbytes	
Height (max)	26.11 mm (1.028 inches)	
Width (max)	101.6 mm (4.000 inches) +/- 0.010 inches	
Length (max)	146.99 mm (5.787 inches)	
Weight (typical)	720 grams	635 grams
Average latency	4.16 msec	
Power-on to ready	16 sec max	
Standby to ready	16 sec max	
Track-to-track seek time	<0.8 msec typical read; <1.0 msec typical write	
Average seek, read	17.0 msec typical	
Average seek, write	14.0 msec typical	
Startup current (typical) 12V (peak)	2.0 amps	
Voltage tolerance (including noise)	5V ± 5% 12V ± 10%	
Ambient temperature	0° to 60°C (operating) –40° to 70°C (nonoperating)	
Temperature gradient	20°C per hour max (operating) 30°C per hour max (nonoperating)	
Relative humidity	5% to 90% (operating) 5% to 95% (nonoperating)	
Relative humidity gradient	30% per hour max	
Wet bulb temperature	37.7°C max (operating) 40.0°C max (nonoperating)	
Altitude, operating	–60.96 m to 3,048 m (–200 ft. to 10,000+ ft.)	
Altitude, nonoperating (below mean sea level, max)	–60.96 m to 12,192 m (–200 ft. to 40,000+ ft.)	
Operational Shock	63 Gs at 2 msec max	
Non-Operational Shock	300 Gs at 2 msec max	

Drive specification	ST3750640AV	ST3500630AV
Vibration, operating	5–22 Hz: 0.02 inches, Limited displacement, peak to peak 22–350 Hz: 0.50 Gs 350–500 Hz: 0.25 Gs	
Vibration, nonoperating	5–350 Hz: 5.0 Gs 350–500 Hz: 1.0 Gs	
Drive acoustics, sound power (bels)		
Idle**	2.8 (typical) 2.9 (max)	
Seek	3.2 (typical) 3.4 (max)	
Nonrecoverable read errors	1 per 10 ¹⁴ bits read	
Annualized Failure Rate (AFR)	0.80%	
Warranty	To determine the warranty for a specific drive, use a web browser to access the following web page: www.seagate.com/support/service/ From this page, click on the “Verify Your Warranty” link. You will be asked to provide the drive serial number, model number (or part number) and country of purchase. The system will display the warranty information for your drive.	
Contact start-stop cycles	50,000 at 25°C, 50% rel. humidity	

*One Gbyte equals one billion bytes when referring to hard drive capacity. Accessible capacity may vary depending on operating environment and formatting.

**During periods of drive idle, some offline activity may occur according to the S.M.A.R.T. specification, which may increase acoustic and power to operational levels.

Table 2: Drive specifications summary for 320, 250 and 160 Gbyte models

Drive specification	ST3320620AV	ST3250820AV	ST3160815AV
Formatted capacity (512 bytes/sector)*	320 Gbytes	250 Gbytes	160 Gbytes
Guaranteed sectors	781,422,768	488,397,168	312,581,808
Heads	4	3	2
Discs	2		1
Bytes per sector	512		
Default sectors per track	63		
Default read/write heads	16		
Default cylinders	16,383		
Recording density	813 kbits/in max		824 kbits/in max
Track density	145 ktracks/in avg		137.259 ktracks/in avg
Areal density	114.4 Gbits/in ² avg		101 Gbits/in ² avg
Spindle speed	7,200 RPM		
Internal data transfer rate	1,030 Mbits/sec max		930 Mbits/sec max
Sustained data transfer rate OD	72 Mbytes/sec max		80 Mbytes/sec max
I/O data-transfer rate	100 Mbytes/sec max		
ATA data-transfer modes supported	PIO modes 0–4 Multiword DMA modes 0–2 Ultra DMA modes 0–6		
Cache buffer	16 Mbytes	8 Mbytes	
Height (max)	26.11 mm (1.028 inches)		20.0 mm (0.787 inches)
Width (max)	101.6 mm (4.000 inches) +/- 0.010 inches		
Length (max)	146.99 mm (5.787 inches)		
Weight (typical)	600 grams		345 grams
Average latency	4.16 msec		
Power-on to ready	16 sec max		
Standby to ready	16 sec max		
Track-to-track seek time	<0.8 msec typical read, <1.0 msec typical write		
Average seek, read	17.0 msec typical		
Average seek, write	14.0 msec typical		
Startup current (typical) 12V (peak)	2.0 amps		
Voltage tolerance (including noise)	5V ± 5% 12V ± 10%		
Ambient temperature	0° to 60°C per hour max (operating) –40° to 70°C per hour max (nonoperating)		
Temperature gradient	20°C (operating) 30°C (nonoperating)		
Relative humidity	5% to 90% (operating) 5% to 95% (nonoperating)		
Relative humidity gradient	30% per hour max		
Wet bulb temperature	37.7°C max (operating) 40.0°C max (nonoperating)		
Altitude, operating	–60.96 m to 3,048 m (–200 ft. to 10,000+ ft.)		
Altitude, nonoperating (below mean sea level, max)	–60.96 m to 12,192 m (–200 ft. to 40,000+ ft.)		
Operational Shock	63 Gs max at 2 msec		
Non-Operational Shock	300 Gs max at 2 msec		350 Gs max at 2 msec

Drive specification	ST3320620AV	ST3250820AV	ST3160815AV
Vibration, operating	5–22 Hz: 0.02 inches, Limited displacement, peak to peak 22–350 Hz: 0.50 Gs 350–500 Hz: 0.25 Gs		
Vibration, nonoperating	5–350 Hz: 5.0 Gs 350–500 Hz: 1.0 Gs		
Drive acoustics, sound power (bels)			
Idle**	2.8 (typical) 2.9 (max)	2.6 (typical) 2.7 (max)	2.5 (typical) 2.6 (max)
Seek	3.0 (typical) 3.1 (max)		3.1 (typical) 3.2 (max)
Nonrecoverable read errors	1 per 10 ¹⁴ bits read		
Annualized Failure Rate (AFR)	0.80%		
Warranty	<p>To determine the warranty for a specific drive, use a web browser to access the following web page: www.seagate.com/support/service/</p> <p>From this page, click on the “Verify Your Warranty” link. You will be asked to provide the drive serial number, model number (or part number) and country of purchase. The system will display the warranty information for your drive.</p>		
Contact start-stop cycles	50,000 at 25°C, 50% rel. humidity		

*One Gbyte equals one billion bytes when referring to hard drive capacity. Accessible capacity may vary depending on operating environment and formatting.

**During periods of drive idle, some offline activity may occur according to the S.M.A.R.T. specification, which may increase acoustic and power to operational levels.

2.2 Formatted capacity

Model	Formatted capacity*	Guaranteed sectors	Bytes per sector
ST3750640AV	750 Gbytes	1,465,149,168	512
ST3500630AV	500 Gbytes	976,773,168	512
ST3320620AV	320 Gbytes	781,422,768	512
ST3250820AV	250 Gbytes	488,397,168	512
ST3160815AV	160 Gbytes	312,581,808	512

*One Gbyte equals one billion bytes when referring to hard drive capacity. Accessible capacity may vary depending on operating environment and formatting.

2.2.1 LBA mode

When addressing these drives in LBA mode, all blocks (sectors) are consecutively numbered from 0 to $n-1$, where n is the number of guaranteed sectors as defined above.

See Section 4.1.2, "Identify Device command" (words 60-61 and 100-103) for additional information about 48-bit addressing support of drives with capacities over 137 Gbytes.

2.3 Default logical geometry

Cylinders	Read/write heads	Sectors per track
16,383	16	63

2.4 Recording and interface technology

	750GB	500GB	320GB	250GB	160GB
Interface	ATA				
Recording method	Perpendicular				
Recording density, KBPI (kbits/inch max)	926	813		824	
Track density, KTPI (ktracks/inch avg)	145			137.259	
Areal density (Gbits/inch ² avg)	128.2	114.4		101	
Spindle speed (RPM) (± 0.2%)	7,200				
Internal data transfer rate (Mbits/sec max)	1,030				
Sustained data transfer rate (Mbytes/sec max)	78	72		80	
I/O data-transfer rate (Mbytes/sec max)	100 (Ultra DMA mode 5)				

2.5 Physical characteristics

Drive specification		
Maximum height		
4, 3 and 2 disc models	(mm) (inches)	26.1 1.028
1 disc model	(mm) (inches)	20.0 0.787
Maximum width	(mm) (inches)	101.6 4.000 +/- 0.010
Maximum length	(mm) (inches)	146.99 5.787
Typical weight	1 disc models 2 disc models 3 disc models 4 disc models	345 grams (0.76 lbs) 600 grams (1.32 lbs) 635 grams (1.40 lbs) 720 grams (1.59 lbs)
Cache Size	ST3750640AV ST3500630AV ST3320620AV ST3250820AV ST3160815AV	16 Mbytes 8 Mbytes

2.6 Seek time

Seek measurements are taken with nominal power at 25°C ambient temperature. All times are measured using drive diagnostics. The specifications in the table below are defined as follows:

- Track-to-track seek time is an average of all possible single-track seeks in both directions.
- Average seek time is a true statistical random average of at least 5,000 measurements of seeks between random tracks, less overhead.

*Typical seek times (msec)	Read	Write
Track-to-track	<0.8	<1.0
Average	17.0	14.0
Average latency:	4.16	4.16

*Measured in quiet mode

Note. These drives are designed to consistently meet the seek times represented in this manual. Physical seeks, regardless of mode (such as track-to-track and average), are expected to meet or exceed the noted values. However, due to the manner in which these drives are formatted, benchmark tests that include command overhead or measure logical seeks may produce results that vary from these specifications.

2.7 Start/stop times

Power-on to Ready (sec)	16 (max)
Standby to Ready (sec)	16 (max)
Ready to spindle stop (sec)	10 (max)

2.8 Power specifications

The drive receives

(+5V or +12V) through a four-pin standard drive power connector.

2.8.1 Power consumption

Power requirements for the drives are listed in the table on page 11. Typical power measurements are based on an average of drives tested, under nominal conditions, using +5.0V and +12.0V input voltage at 25°C ambient temperature.

- **Spinup power**

Spinup power is measured from the time of power-on to the time that the drive spindle reaches operating speed.

- **Seek mode**

During seek mode, the read/write actuator arm moves toward a specific position on the disc surface and does not execute a read or write operation. Servo electronics are active. Seek mode power represents the worst-case power consumption, using only random seeks with read or write latency time. This mode is not typical and is provided for worst-case information.

- **Read/write power and current**

Read/write power is measured with the heads on track, based on a 16-sector write followed by a 32-msec delay, then a 16-sector read followed by a 32-msec delay.

- **Operating power and current**

Operating power is measured using 40 percent random seeks, 40 percent read/write mode (1 write for each 10 reads) and 20 percent drive idle mode.

- **Idle mode power**

Idle mode power is measured with the drive up to speed, with servo electronics active and with the heads in a random track location.

- **Standby mode**

During Standby mode, the drive accepts commands, but the drive is not spinning, and the servo and read/write electronics are in power-down mode.

Table 3: DC power requirements

Power dissipation (4-Disc values shown)	Avg (watts, 25° C)	Avg 5V typ amps	Avg 12V typ amps
Spinup	—	—	2.0 (peak)
Idle*	9.30	0.611	0.540
Idle with offline activity	10.40	0.719	0.567
Operating (40% r/w, 40% seek, 20% inop.) ST3750640AV ST3500630AV ST3320620AV, ST3250820AV ST3160815AV	8.2 7.5 6.5 5.7	0.425	0.510
Standby	0.80	0.106	0.023
Sleep	0.80	0.106	0.023

*During periods of drive idle, some offline activity may occur according to the S.M.A.R.T. specification, which may increase acoustic and power to operational levels.

2.8.1.1 Typical current profile

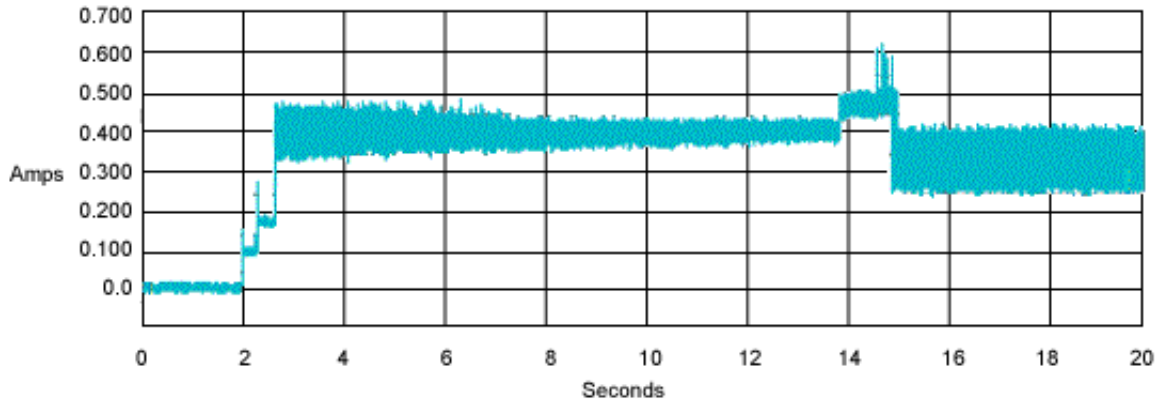

Figure 1 Typical 5V startup and operation current profile

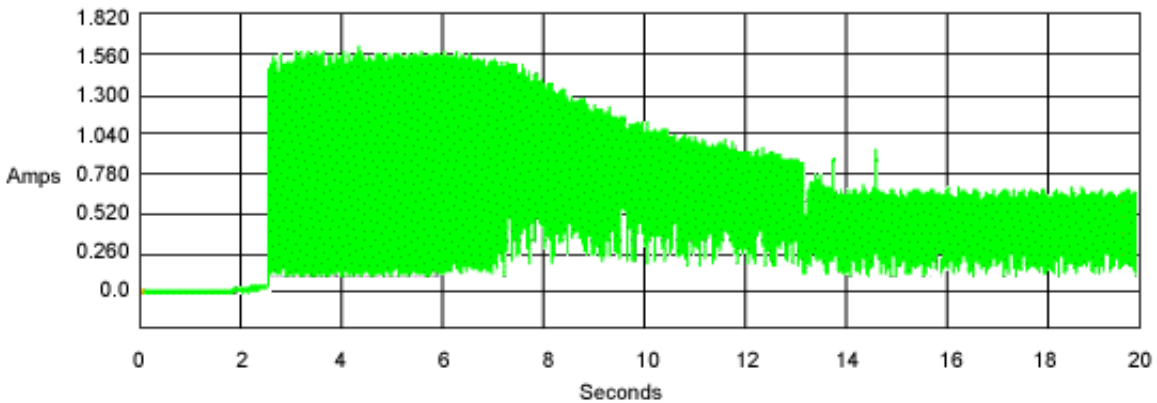

Figure 2 Typical 12V startup and operation current profile

2.8.2 Conducted noise

Input noise ripple is measured at the host system power supply across an equivalent 80-ohm resistive load on the +12 volt line or an equivalent 15-ohm resistive load on the +5 volt line.

- Using 12-volt power, the drive is expected to operate with a maximum of 120 mV peak-to-peak square-wave injected noise at up to 10 MHz.
- Using 5-volt power, the drive is expected to operate with a maximum of 100 mV peak-to-peak square-wave injected noise at up to 10 MHz.

Note. Equivalent resistance is calculated by dividing the nominal voltage by the typical RMS read/write current.

2.8.3 Voltage tolerance

Voltage tolerance (including noise):

- 5V \pm 5%
- 12V \pm 10%

2.8.4 Power management modes

The drive provides programmable power management to provide greater energy efficiency. In most systems, you can control power management through the system setup program. The drive features the following power management modes:

Power mode	Heads	Spindle	Buffer
Active	Tracking	Rotating	Enabled
Idle	Tracking	Rotating	Enabled
Standby	Parked	Stopped	Enabled
Sleep	Parked	Stopped	Disabled

- **Active mode**

The drive is in Active mode during the read/write and seek operations.

- **Idle mode**

The buffer remains enabled, and the drive accepts all commands and returns to Active mode any time disc access is necessary.

- **Standby mode**

The drive enters Standby mode when the host sends a Standby Immediate command. If the host has set the standby timer, the drive can also enter Standby mode automatically after the drive has been inactive for a specifiable length of time. The standby timer delay is established using a Standby or Idle command. In Standby mode, the drive buffer is enabled, the heads are parked and the spindle is at rest. The drive accepts all commands and returns to Active mode any time disc access is necessary.

- **Sleep mode**

The drive enters Sleep mode after receiving a Sleep command from the host. In Sleep mode, the drive buffer is disabled, the heads are parked and the spindle is at rest. The drive leaves Sleep mode after it receives a Hard Reset or Soft Reset from the host. After receiving a reset, the drive exits Sleep mode and enters Standby mode with all current translation parameters intact.

- **Idle and Standby timers**

Each time the drive performs an Active function (read, write or seek), the standby timer is reinitialized and begins counting down from its specified delay times to zero. If the standby timer reaches zero before any drive activity is required, the drive makes a transition to Standby mode. In both Idle and Standby mode, the drive accepts all commands and returns to Active mode when disc access is necessary.

2.9 Environmental specifications

2.9.1 Ambient temperature

Ambient temperature is defined as the temperature of the environment immediately surrounding the drive. Actual drive case temperature should not exceed 69°C (156°F) within the operating ambient conditions. Recommended measurement locations are shown in See Figure 6 on page 25.

Above 1,000 feet (305 meters), the maximum temperature is derated linearly to 112°F (44°C) at 10,000 feet (3,048 meters).

Operating:	0° to 60°C (32° to 140°F)
Nonoperating:	–40° to 70°C (–40° to 158°F)

2.9.2 Temperature gradient

Operating:	20°C per hour (68°F per hour max), without condensation
Nonoperating:	30°C per hour (86°F per hour max)

2.9.3 Humidity

2.9.3.1 Relative humidity

Operating:	5% to 90% noncondensing (30% per hour max)
Nonoperating:	5% to 95% noncondensing (30% per hour max)

2.9.3.2 Wet bulb temperature

Operating:	37.7°C (99.9°F max)
Nonoperating:	40.0°C (104.0°F max)

2.9.4 Altitude

Operating:	–60.96 m to 3,048 m (–200 ft. to 10,000+ ft.)
Nonoperating:	–60.96 m to 12,192 m (–200 ft. to 40,000+ ft.)

2.9.5 Shock

All shock specifications assume that the drive is mounted securely with the input shock applied at the drive mounting screws. Shock may be applied in the X, Y or Z axis.

2.9.5.1 Operating shock

These drives comply with the performance levels specified in this document when subjected to a maximum operating shock of 63 Gs based on half-sine shock pulses of 2 msec. Shocks should not be repeated more than two times per second.

2.9.5.2 Nonoperating shock

1 Disc models

The nonoperating shock level that the drive can experience without incurring physical damage or degradation in performance when subsequently put into operation is 350 Gs based on a nonrepetitive half-sine shock pulse of 2 msec duration.

2, 3 and 4 Disc models

The nonoperating shock level that the drive can experience without incurring physical damage or degradation in performance when subsequently put into operation is 300 Gs based on a nonrepetitive half-sine shock pulse of 2 msec duration.

2.9.6 Vibration

All vibration specifications assume that the drive is mounted securely with the input vibration applied at the drive mounting screws. Vibration may be applied in the X, Y or Z axis.

2.9.6.1 Operating vibration

The following table lists the maximum vibration levels that the drive may experience while meeting the performance standards specified in this document.

5–22 Hz	0.02 inches (Limited displacement, peak to peak)
22–350 Hz	0.50 Gs
350–500 Hz	0.25 Gs

2.9.6.2 Nonoperating vibration

The following table lists the maximum nonoperating vibration that the drive may experience without incurring physical damage or degradation in performance when subsequently put into operation.

5–350 Hz	5.0 Gs
350–500 Hz	1.0 Gs

2.10 Acoustics

Drive acoustics are measured as overall A-weighted acoustic sound power levels (no pure tones). All measurements are consistent with ISO document 7779. Sound power measurements are taken under essentially free-field conditions over a reflecting plane. For all tests, the drive is oriented with the cover facing upward.

Note. For seek mode tests, the drive is placed in seek mode only. The number of seeks per second is defined by the following equation:

$$(\text{Number of seeks per second} = 0.4 / (\text{average latency} + \text{average access time}))$$

Table 4: Fluid Dynamic Bearing (FDB) motor acoustics

Acoustic mode		
	Idle*	Seek
ST3750640AV ST3500630AV	2.8 bels (typ) 2.9 bels (max)	3.2 bels (typ) 3.4 bels (max)
ST3320620AV	2.8 bels (typ) 2.9 bels (max)	3.0 bels (typ) 3.1 bels (max)
ST3250820AV	2.6 bels (typ) 2.7 bels (max)	3.0 bels (typ) 3.1 bels (max)
ST3160815AV	2.5 bels (typ) 2.6 bels (max)	3.1 bels (typ) 3.2 bels (max)

*During periods of drive idle, some offline activity may occur according to the S.M.A.R.T. specification, which may increase acoustic and power to operational levels.

2.11 Electromagnetic immunity

When properly installed in a representative host system, the drive operates without errors or degradation in performance when subjected to the radio frequency (RF) environments defined in the following table:

Table 5: Radio frequency environments

Test	Description	Performance level	Reference standard
Electrostatic discharge	Contact, HCP, VCP: ± 4 kV; Air: ± 8 kV	B	EN 61000-4-2: 95
Radiated RF immunity	80 to 1,000 MHz, 3 V/m, 80% AM with 1 kHz sine 900 MHz, 3 V/m, 50% pulse modulation @ 200 Hz	A	EN 61000-4-3: 96 ENV 50204: 95
Electrical fast transient	± 1 kV on AC mains, ± 0.5 kV on external I/O	B	EN 61000-4-4: 95
Surge immunity	± 1 kV differential, ± 2 kV common, AC mains	B	EN 61000-4-5: 95
Conducted RF immunity	150 kHz to 80 MHz, 3 Vrms, 80% AM with 1 kHz sine	A	EN 61000-4-6: 97
Voltage dips, interrupts	0% open, 5 seconds 0% short, 5 seconds 40%, 0.10 seconds 70%, 0.01 seconds	C C C B	EN 61000-4-11: 94

2.12 Reliability

2.12.1 Annualized Failure Rate (AFR) and Mean Time Between Failures (MTBF)

The product shall achieve an Annualized Failure Rate (AFR) of 0.80% (MTBF of 1+ million hours) when operated in an environment of ambient air temperatures of 25°C, assuming delta between ambient air temperature and HDD case temperature is less than 15°C. Operation at temperatures outside the specifications in Section 2.9 may increase the product AFR (decrease MTBF). AFR and MTBF are population statistics that are not relevant to individual units.

AFR and MTBF specifications are based on the following assumptions for Digital Video Surveillance computer environments:

- 8760 power-on-hours per year.
- 10,000 average motor start/stop cycles per year.
- Operations at nominal voltages.
- Temperatures outside the specifications in Section 2.9 may reduce the product reliability.
- Normal I/O duty cycle for desktop personal computers. Operation at excessive I/O duty cycle may degrade product reliability.

The desktop personal computer environment of power-on-hours, temperature, and I/O duty cycle affect the product AFR and MTBF. The AFR and MTBF will be degraded if used in an enterprise application.

Nonrecoverable read errors	1 per 10 ¹⁴ bits read, max
Annualized Failure Rate (AFR)	0.80% (nominal power, 25°C ambient temperature)
Contact start-stop cycles	50,000 cycles (at nominal voltage and temperature, with 60 cycles per hour and a 50% duty cycle)
Warranty	To determine the warranty for a specific drive, use a web browser to access the following web page: www.seagate.com/support/service/ From this page, click on the “Verify Your Warranty” link. You will be asked to provide the drive serial number, model number (or part number) and country of purchase. The system will display the warranty information for your drive.
Preventive maintenance	None required.

2.13 Agency certification

2.13.1 Safety certification

The drives are recognized in accordance with UL 1950 and CSA C22.2 (950) and meet all applicable sections of IEC950 and EN 60950.

2.13.2 Electromagnetic compatibility

Hard drives that display the CE mark comply with the European Union (EU) requirements specified in the Electromagnetic Compatibility Directive (89/336/EEC). Testing is performed to the levels specified by the product standards for Information Technology Equipment (ITE). Emission levels are defined by EN 55022, Class B and the immunity levels are defined by EN 55024.

Drives are tested in representative end-user systems. Although CE-marked Seagate drives comply with the directives when used in the test systems, we cannot guarantee that all systems will comply with the directives. The drive is designed for operation inside a properly designed enclosure, with properly shielded I/O cable (if necessary) and terminators on all unused I/O ports. Computer manufacturers and system integrators should confirm EMC compliance and provide CE marking for their products.

Korean RRL

If these drives have the Korea Ministry of Information and Communication (MIC) logo, they comply with paragraph 1 of Article 11 of the Electromagnetic Compatibility control Regulation and meet the Electromagnetic Compatibility (EMC) Framework requirements of the Radio Research Laboratory (RRL) Ministry of Information and Communication Republic of Korea.

These drives have been tested and comply with the Electromagnetic Interference/Electromagnetic Susceptibility (EMI/EMS) for Class B products. Drives are tested in a representative, end-user system by a Korean-recognized lab.

- Family name: SV35.2 Series
- Certificate number: STX-L3510(B)

Australian C-Tick (N176)

If these models have the C-Tick marking, they comply with the Australia/New Zealand Standard AS/NZS3548 1995 and meet the Electromagnetic Compatibility (EMC) Framework requirements of the Australian Communication Authority (ACA).

2.13.3 FCC verification

These drives are intended to be contained solely within a personal computer or similar enclosure (not attached as an external device). As such, each drive is considered to be a subassembly even when it is individually marketed to the customer. As a subassembly, no Federal Communications Commission verification or certification of the device is required.

Seagate Technology LLC has tested this device in enclosures as described above to ensure that the total assembly (enclosure, disc drive, motherboard, power supply, etc.) does comply with the limits for a Class B computing device, pursuant to Subpart J, Part 15 of the FCC rules. Operation with noncertified assemblies is likely to result in interference to radio and television reception.

Radio and television interference. This equipment generates and uses radio frequency energy and if not installed and used in strict accordance with the manufacturer's instructions, may cause interference to radio and television reception.

This equipment is designed to provide reasonable protection against such interference in a residential installation. However, there is no guarantee that interference will not occur in a particular installation. If this equipment does cause interference to radio or television, which can be determined by turning the equipment on and off, you are encouraged to try one or more of the following corrective measures:

- Reorient the receiving antenna.
- Move the device to one side or the other of the radio or TV.
- Move the device farther away from the radio or TV.
- Plug the computer into a different outlet so that the receiver and computer are on different branch outlets.

If necessary, you should consult your dealer or an experienced radio/television technician for additional suggestions. You may find helpful the following booklet prepared by the Federal Communications Commission: *How to Identify and Resolve Radio-Television Interference Problems*. This booklet is available from the Superintendent of Documents, U.S. Government Printing Office, Washington, DC 20402. Refer to publication number 004-000-00345-4.

2.14 Environmental protection

Seagate designs its products to meet environmental protection requirements worldwide, including regulations restricting certain chemical substances.

2.14.1 European Union Restriction of Hazardous Substances (RoHS)

The European Union Restriction of Hazardous Substances (RoHS) Directive restricts the presence of chemical substances, including Lead (Pb), in electronic products effective July 2006.

A number of parts and materials in Seagate products are procured from external suppliers. We rely on the representations of our suppliers regarding the presence of RoHS substances in these parts and materials. Our supplier contracts require compliance with our chemical substance restrictions, and our suppliers document their compliance with our requirements by providing material content declarations for all parts and materials for the disc drives documented in this publication. Current supplier declarations include disclosure of the inclusion of any RoHS-regulated substance in such parts or materials.

Seagate also has internal systems in place to ensure ongoing compliance with the RoHS Directive and all laws and regulations which restrict chemical content in electronic products. These systems include standard operating procedures that ensure that restricted substances are not utilized in our manufacturing operations, laboratory analytical validation testing, and an internal auditing process to ensure that all standard operating procedures are complied with.

2.15 Corrosive environment

Seagate electronic drive components pass accelerated corrosion testing equivalent to 10 years exposure to light industrial environments containing sulfurous gases, chlorine and nitric oxide, classes G and H per ASTM B845. However, this accelerated testing cannot duplicate every potential application environment. Users should use caution exposing any electronic components to uncontrolled chemical pollutants and corrosive chemicals as electronic drive component reliability can be affected by the installation environment. The silver, copper, nickel and gold films used in Seagate products are especially sensitive to the presence of sulfide, chloride, and nitrate contaminants. Sulfur is found to be the most damaging. In addition, electronic components should never be exposed to condensing water on the surface of the printed circuit board assembly (PCBA) or exposed to an ambient relative humidity greater than 95%. Materials used in cabinet fabrication, such as vulcanized rubber, that can outgas corrosive compounds should be minimized or eliminated. The useful life of any electronic equipment may be extended by replacing materials near circuitry with sulfide-free alternatives.

3.0 Configuring and mounting the drive

This section contains the specifications and instructions for configuring and mounting the drive.

3.1 Handling and static discharge precautions

After unpacking, and before installation, the drive may be exposed to potential handling and electrostatic discharge (ESD) hazards. Observe the following standard handling and static-discharge precautions:

Caution:

- Before handling the drive, put on a grounded wrist strap, or ground yourself frequently by touching the metal chassis of a computer that is plugged into a grounded outlet. Wear a grounded wrist strap throughout the entire installation procedure.
- Handle the drive by its edges or frame *only*.
- The drive is extremely fragile—handle it with care. Do not press down on the drive top cover.
- Always rest the drive on a padded, antistatic surface until you mount it in the computer.
- Do not touch the connector pins or the printed circuit board.
- Do not remove the factory-installed labels from the drive or cover them with additional labels. Removal voids the warranty. Some factory-installed labels contain information needed to service the drive. Other labels are used to seal out dirt and contamination.

3.2 Breather filter hole precautions

This section contains information regarding the precautions which should be taken regarding the breather filter hole in Seagate hard disc drives. Proper precautions should be taken to ensure full functionality and prevent possible damage to the drive.

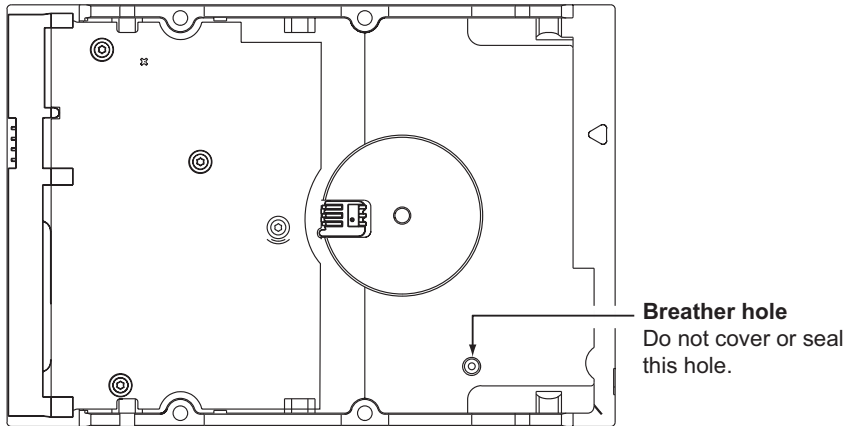

Figure 3 Breather filter hole location

Caution: Do not cover, seal, or insert any object into this hole.

This hole has two purposes:

- To allow condensation inside the hard disc to escape
- To allow air pressure inside the hard disc to equalize with ambient pressure

Note. If this hole is covered, sealed, or penetrated by any object, the drive reliability may be compromised and could lead to permanent damage. Covering or sealing this hole voids the warranty.

3.3 Jumper settings

3.3.1 Master/slave configuration

The options jumper block shown in Figure 4 is used to configure the drive for operation. It is the 8-pin dual header between the interface connector and the power connector. Use the following settings to configure the drive as a master or a slave.

Master or single drive. The drive is configured at the factory for a master or single drive operation with a jumper set on pins 7 and 8.

Drive as slave. Remove all jumpers.

Drive as master with a non-ATA-compatible slave.

Use this jumper setting *only* if the drive does not work as a master with no jumpers installed.

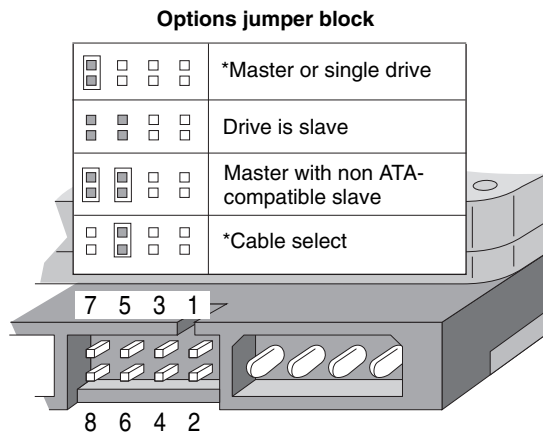

Figure 4 Master/slave jumper settings

3.3.2 Cable-select option

Computers that use cable select determine the master and slave drives by selecting or deselecting pin 28, CSEL, on the interface bus. Master and slave drives are determined by their physical position on the cable. To enable cable select, set a jumper on pins 5 and 6 as shown in Figure 4. Refer to your computer manual to determine whether your computer supports this option.

3.3.3 Ultra ATA/100 cable

An 80-conductor 40-pin cable is required to run Ultra DMA mode 3, mode 4, and mode 5. This cable uses even-numbered conductors connected to the ground pins to improve signal integrity.

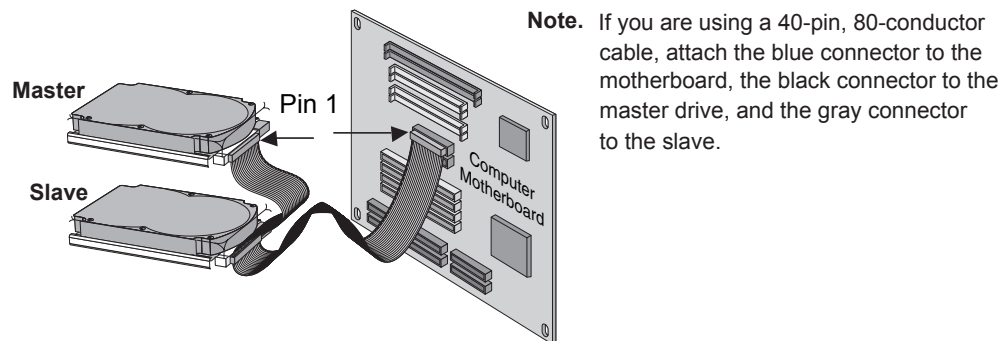

Figure 5 Ultra ATA cable connectors

Note. The drive supports both host and drive cable detection. The host detects the 80-conductor cable by sampling pin 34, CBLID $^-$, on the interface bus. The drive detects the 80-conductor cable by sensing a capacitor at the host side through the CBLID $^-$ signal. The result is reported in a Fast Rise Detected bit (bit 13 of word 93 in the Identify drive parameter block).

3.4 Drive mounting

You can mount the drive in any orientation using four screws in the side-mounting holes or four screws in the bottom-mounting holes. See Figure 6 for drive mounting dimensions. Follow these important mounting precautions when mounting the drive:

- Allow a minimum clearance of 0.030 inches (0.76 mm) around the entire perimeter of the drive for cooling.
- Use only 6-32 UNC mounting screws.
- Do not overtighten the mounting screws (maximum torque: 6 inch-lb.).
- Do not use a drive interface cable that is more than 18 inches long.

Notes:

1. Dimensions are shown in inches (mm).
2. Dimensions per SFF-8301 specification.

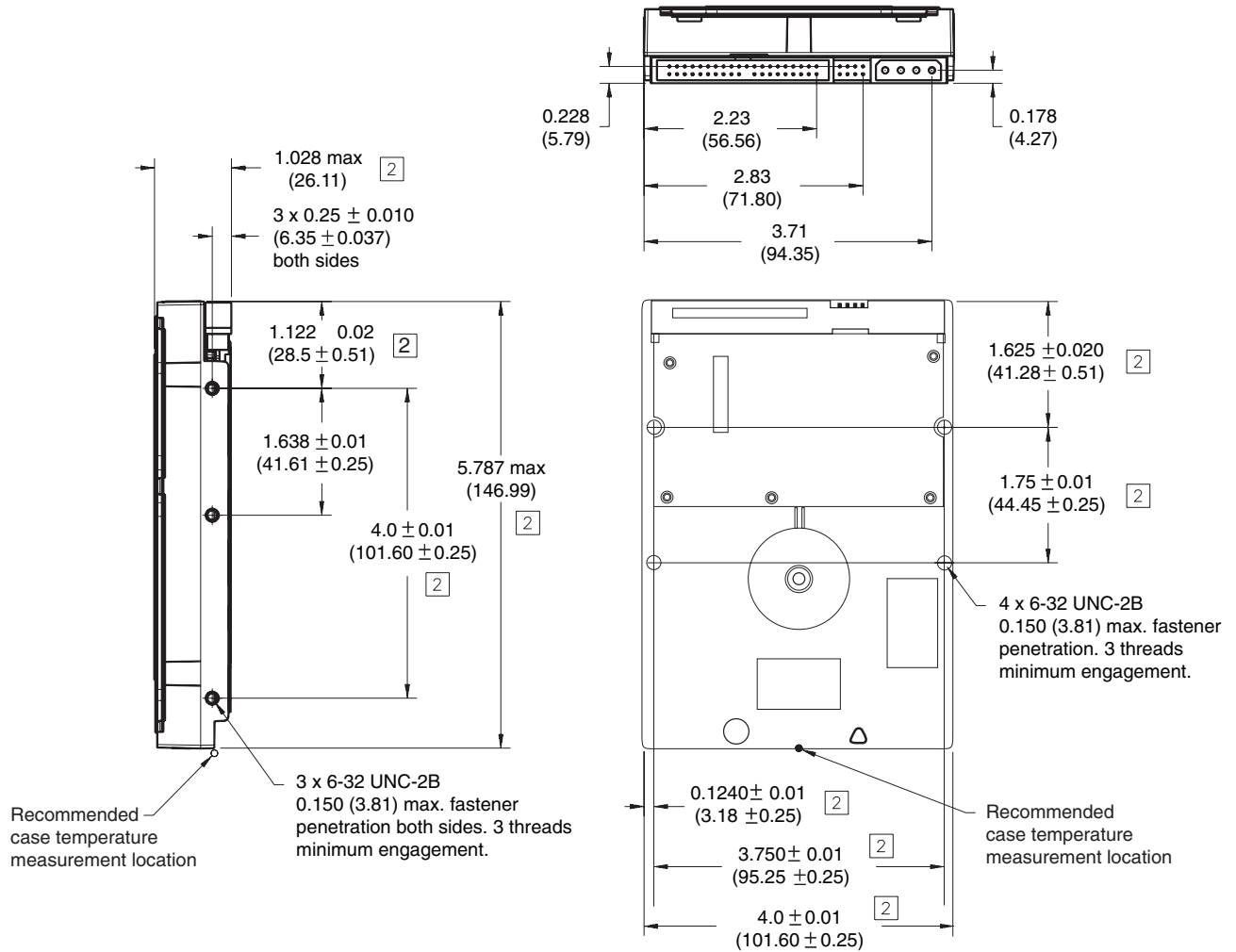

Figure 6 Mounting dimensions—top, side and end view

4.0 ATA interface

These drives use the industry-standard ATA task file interface that supports 16-bit data transfers. It supports ATA programmed input/output (PIO) modes 0–4; multiword DMA modes 0–2, and Ultra DMA modes 0–5. The drive also supports the use of the IORDY signal to provide reliable high-speed data transfers.

You can use a daisy-chain cable to connect two drives to a single AT host bus. For detailed information about the ATA interface, refer to the draft of *AT Attachment with Packet Interface Extension (ATA/ATAPI-7)*, *NCITS T13 1410D*, subsequently referred to as the *Draft ATA-7 Standard*.

4.1 ATA interface signals and connector pins

Figure 7 on page 27 summarizes the signals on the ATA interface connector that the drive supports. For a detailed description of these signals, refer to the *Draft ATA-7 Standard*.

Drive pin #	Signal name	Host pin # and signal description
1	Reset-	1 Hardware Reset
2	Ground	2 Ground
3	DD7	3 Host Data Bus Bit 7
4	DD8	4 Host Data Bus Bit 8
5	DD6	5 Host Data Bus Bit 6
6	DD9	6 Host Data Bus Bit 9
7	DD5	7 Host Data Bus Bit 5
8	DD10	8 Host Data Bus Bit 10
9	DD4	9 Host Data Bus Bit 4
10	DD11	10 Host Data Bus Bit 11
11	DD3	11 Host Data Bus Bit 3
12	DD12	12 Host Data Bus Bit 12
13	DD2	13 Host Data Bus Bit 2
14	DD13	14 Host Data Bus Bit 13
15	DD1	15 Host Data Bus Bit 1
16	DD14	16 Host Data Bus Bit 14
17	DD0	17 Host Data Bus Bit 0
18	DD15	18 Device Data (15:0)
19	Ground	19 Ground
20	(removed)	20 (No Pin)
21	DMARQ	21 DMA Request
22	Ground	22 Ground
23	DIOW-	23 Device I/O Write: Stop Ultra DMA Burst
24	Ground	24 Ground
25	DIOR-	25 Device I/O Read: Host Ultra DMA Ready: Host Ultra DMA Data Strobe
26	Ground	26 Ground
27	IORDY	27 I/O Channel Ready
	DDMARDY-	Device Ultra DMA Ready
	DSTROBE	Device Ultra DMA Data Strobe
28	CSEL	28 Cable Select
29	DMACK-	29 DMA Acknowledge
30	Ground	30 Ground
31	INTRQ	31 Device Interrupt
32	IOCS16-	32 Reserved
33	DA1	33 Host Address Bus Bit 1
34	PDIAG-	34 Passed Diagnostics
	CBLID-	Cable Assembly Type Identifier
35	DA0	35 Device Address (2:0)
36	DA2	36 Device Address (2:0)
37	CS0-	37 Chip Select (1:0)
38	CS1-	38 Chip Select (1:0)
39	DASP-	39 Drive Active/Slave Present
40	Ground	40 Ground

Pins 28, 34 and 39 are used for master-slave communication (details shown below).

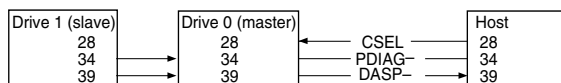

Figure 7 I/O pins and supported ATA signals

4.1.1 Supported ATA commands

The following table lists ATA-standard commands that the drive supports. For a detailed description of the ATA commands, refer to the *Draft ATA-7 Standard*. See “S.M.A.R.T. commands” on page 34 for details and sub-commands used in the S.M.A.R.T. implementation.

Table 6: Supported ATA commands

Command name	Command code (in hex)
Check Power Mode	98 _H or E5 _H
Device Configuration Freeze Lock	B1 _H / C1 _H
Device Configuration Identify	B1 _H / C2 _H
Device Configuration Restore	B1 _H / C0 _H
Device Configuration Set	B1 _H / C3 _H
Device Reset	08 _H
Download Microcode	92 _H
Execute Device Diagnostics	90 _H
Flush Cache	E7 _H
Flush Cache Extended	EA _H
Format Track	50 _H
Identify Device	EC _H
Idle	97 _H or E3 _H
Idle Immediate	95 _H or E1 _H
Initialize Device Parameters	91 _H
Read Buffer	E4 _H
Read DMA	C8 _H
Read DMA Extended	25 _H
Read DMA Without Retries	C9 _H
Read Log Ext	2F _H
Read Multiple	C4 _H
Read Multiple Extended	29 _H
Read Native Max Address	F8 _H
Read Native Max Address Extended	27 _H
Read Sectors	20 _H
Read Sectors Extended	24 _H
Read Sectors Without Retries	21 _H
Read Verify Sectors	40 _H
Read Verify Sectors Extended	42 _H
Read Verify Sectors Without Retries	41 _H
Recalibrate	10 _H
Security Disable Password	F6 _H
Security Erase Prepare	F3 _H

Command name	Command code (in hex)
Security Erase Unit	F4 _H
Security Freeze	F5 _H
Security Set Password	F1 _H
Security Unlock	F2 _H
Seek	70 _H
Set Features	EF _H
Set Max Address Note: Individual Set Max Address commands are identified by the value placed in the Set Max Features register as defined to the right.	F9 _H Address: 00 _H Password: 01 _H Lock: 02 _H Unlock: 03 _H Freeze Lock: 04 _H
Set Max Address Extended	37 _H
Set Multiple Mode	C6 _H
Sleep	99 _H or E6 _H
S.M.A.R.T. Disable Operations	B0 _H / D9 _H
S.M.A.R.T. Enable/Disable Autosave	B0 _H / D2 _H
S.M.A.R.T. Enable Operations	B0 _H / D8 _H
S.M.A.R.T. Execute Offline	B0 _H / D4 _H
S.M.A.R.T. Read Attribute Thresholds	B0 _H / D1 _H
S.M.A.R.T. Read Data	B0 _H / D0 _H
S.M.A.R.T. Read Log Sector	B0 _H / D5 _H
S.M.A.R.T. Return Status	B0 _H / DA _H
S.M.A.R.T. Save Attribute Values	B0 _H / D3 _H
S.M.A.R.T. Write Log Sector	B0 _H / D6 _H
Standby	96 _H or E2 _H
Standby Immediate	94 _H or E0 _H
Write Buffer	E8 _H
Write DMA	CA _H
Write DMA Extended	35 _H
Write DMA Without Retries	CB _H
Write Log Extended	3F _H
Write Multiple	C5 _H
Write Multiple Extended	39 _H
Write Sectors	30 _H
Write Sectors Without Retries	31 _H
Write Sectors Extended	34 _H

4.1.2 Identify Device command

The Identify Device command (command code EC_H) transfers information about the drive to the host following power up. The data is organized as a single 512-byte block of data, whose contents are shown in the Table 6 on page 28. All reserved bits or words should be set to zero. Parameters listed with an “x” are drive-specific or vary with the state of the drive. See Section 2.0 on page 3 for default parameter settings.

The following commands contain drive-specific features that may not be included in the *Draft ATA-7 Standard*.

Word	Description	Value
0	Configuration information: • Bit 15: 0 = ATA; 1 = ATAPI • Bit 7: removable media • Bit 6: removable controller • Bit 0: reserved	0C5A _H
1	Number of logical cylinders	16,383
2	ATA-reserved	0000 _H
3	Number of logical heads	16
4	Retired	0000 _H
5	Retired	0000 _H
6	Number of logical sectors per logical track: 63	003F _H
7–9	Retired	0000 _H
10–19	Serial number: (20 ASCII characters, 0000 _H = none)	ASCII
20	Retired	0000 _H
21	Retired	0400 _H
22	Obsolete	0000 _H
23–26	Firmware revision (8 ASCII character string, padded with blanks to end of string)	x.xx
27–46	Drive model number (40 ASCII characters, padded with blanks to end of string)	ST3xxxxxA
47	(Bits 7–0) Maximum sectors per interrupt on Read multiple and Write multiple (16)	8010 _H
48	Reserved	0000 _H
49	Standard Standby timer, IORDY supported and may be disabled	2F00 _H
50	ATA-reserved	0000 _H
51	PIO data-transfer cycle timing mode	0200 _H
52	Retired	0200 _H
53	Words 54–58, 64–70 and 88 are valid	0007 _H
54	Number of current logical cylinders	xxxx _H
55	Number of current logical heads	xxxx _H
56	Number of current logical sectors per logical track	xxxx _H
57–58	Current capacity in sectors	xxxx _H
59	Number of sectors transferred during a Read Multiple or Write Multiple command	xxxx _H

Word	Description	Value
60–61	Total number of user-addressable LBA sectors available (see Section 2.2 for related information) *Note: The maximum value allowed in this field is: 0FFFFFFFh (268,435,455 sectors, 137 Gbytes). Drives with capacities over 137 Gbytes will have 0FFFFFFFh in this field and the actual number of user-addressable LBAs specified in words 100-103. This is required for drives that support the 48-bit addressing feature.	0FFFFFFFh*
62	Retired	0000 _H
63	Multiword DMA active and modes supported (see note following this table)	xx07 _H
64	Advanced PIO modes supported (modes 3 and 4 supported)	0003 _H
65	Minimum multiword DMA transfer cycle time per word (120 nsec)	0078 _H
66	Recommended multiword DMA transfer cycle time per word (120 nsec)	0078 _H
67	Minimum PIO cycle time without IORDY flow control (240 nsec)	00F0 _H
68	Minimum PIO cycle time with IORDY flow control (120 nsec)	0078 _H
69–74	ATA-reserved	0000 _H
75	Queue depth	0000 _H
76–79	SATA-specific	xxxx _H
80	Major version number	007E _H
81	Minor version number	0000 _H
82	Command sets supported	346B _H
83	Command sets supported	7D01 _H
84	Command sets support extension	4003 _H
85	Command sets enabled	34xx _H
86	Command sets enabled	3xxx _H
87	Command sets enable extension	4003 _H
88	Ultra DMA support and current mode (see note following this table)	xx3F _H
89	Security erase time	0000 _H
90	Enhanced security erase time	0000 _H
92	Master password revision code	FFFE _H
93	Hardware reset value (see description following this table)	xxxx _H
95–99	ATA-reserved	0000 _H
100–103	Total number of user-addressable LBA sectors available (see Section 2.2 for related information). These words are required for drives that support the 48-bit addressing feature. Maximum value: 0000FFFFFFFFFFFFh.	ST3750640AV = 1,465,149,168 ST3500630AV = 976,773,168 ST3320620AV = 781,422,768 ST3250820AV = 488,397,168 ST3160815AV = 312,581,808
104–127	ATA-reserved	0000 _H
128	Security status	0001 _H
129–159	Seagate-reserved	xxxx _H
160–254	ATA-reserved	0000 _H

Word	Description	Value
255	Integrity word	xxA5 _H

Note. Advanced Power Management (APM) and Automatic Acoustic Management (AAM) features are not supported

Note. See the bit descriptions below for words 63, 88, and 93 of the Identify Drive data:

Description (if bit is set to 1)		
	Bit	Word 63
	0	Multiword DMA mode 0 is supported.
	1	Multiword DMA mode 1 is supported.
	2	Multiword DMA mode 2 is supported.
	8	Multiword DMA mode 0 is currently active.
	9	Multiword DMA mode 1 is currently active.
	10	Multiword DMA mode 2 is currently active.
	Bit	Word 88
	0	Ultra DMA mode 0 is supported.
	1	Ultra DMA mode 1 is supported.
	2	Ultra DMA mode 2 is supported.
	3	Ultra DMA mode 3 is supported.
	4	Ultra DMA mode 4 is supported.
	5	Ultra DMA mode 5 is supported.
	8	Ultra DMA mode 0 is currently active.
	9	Ultra DMA mode 1 is currently active.
	10	Ultra DMA mode 2 is currently active.
	11	Ultra DMA mode 3 is currently active.
	12	Ultra DMA mode 4 is currently active.
	13	Ultra DMA mode 5 is currently active.
	Bit	Word 93
	13	1 = 80-conductor cable detected, CBLID above V _{IH} 0 = 40-conductor cable detected, CBLID below V _{IL}

4.1.3 Set Features command

This command controls the implementation of various features that the drive supports. When the drive receives this command, it sets BSY, checks the contents of the Features register, clears BSY and generates an interrupt. If the value in the register does not represent a feature that the drive supports, the command is aborted. Power-on default has the read look-ahead and write caching features enabled. The acceptable values for the Features register are defined as follows:

02 _H	Enable write cache (<i>default</i>).
03 _H	Set transfer mode (based on value in Sector Count register). Sector Count register values:
00 _H	Set PIO mode to default (PIO mode 2).
01 _H	Set PIO mode to default and disable IORDY (PIO mode 2).
08 _H	PIO mode 0
09 _H	PIO mode 1
0A _H	PIO mode 2
0B _H	PIO mode 3
0C _H	PIO mode 4 (<i>default</i>)
20 _H	Multiword DMA mode 0
21 _H	Multiword DMA mode 1
22 _H	Multiword DMA mode 2
40 _H	Ultra DMA mode 0
41 _H	Ultra DMA mode 1
42 _H	Ultra DMA mode 2
43 _H	Ultra DMA mode 3
44 _H	Ultra DMA mode 4
45 _H	Ultra DMA mode 5
55 _H	Disable read look-ahead (read cache) feature.
82 _H	Disable write cache.
AA _H	Enable read look-ahead (read cache) feature (<i>default</i>).
F1 _H	Report full capacity available

Note. At power-on, or after a hardware or software reset, the default values of the features are as indicated above.

4.1.4 S.M.A.R.T. commands

S.M.A.R.T. provides near-term failure prediction for disc drives. When S.M.A.R.T. is enabled, the drive monitors predetermined drive attributes that are susceptible to degradation over time. If self-monitoring determines that a failure is likely, S.M.A.R.T. makes a status report available to the host. Not all failures are predictable. S.M.A.R.T. predictability is limited to the attributes the drive can monitor. For more information on S.M.A.R.T. commands and implementation, see the *Draft ATA-7 Standard*.

SeaTools diagnostic software activates a built-in drive self-test (DST S.M.A.R.T. command for D4_H) that eliminates unnecessary drive returns. The diagnostic software ships with all new drives and is also available at: <http://seatools.seagate.com>.

This drive is shipped with S.M.A.R.T. features disabled. You must have a recent BIOS or software package that supports S.M.A.R.T. to enable this feature. The table below shows the S.M.A.R.T. command codes that the drive uses.

Code in features register	S.M.A.R.T. command
D0 _H	S.M.A.R.T. Read Data
D2 _H	S.M.A.R.T. Enable/Disable Attribute Autosave
D3 _H	S.M.A.R.T. Save Attribute Values
D4 _H	S.M.A.R.T. Execute Off-line Immediate (runs DST)
D5 _H	S.M.A.R.T. Read Log Sector
D6 _H	S.M.A.R.T. Write Log Sector
D8 _H	S.M.A.R.T. Enable Operations
D9 _H	S.M.A.R.T. Disable Operations
DA _H	S.M.A.R.T. Return Status

Note. If an appropriate code is not written to the Features Register, the command is aborted and 0x04 (abort) is written to the Error register.

5.0 Seagate Technology support services

Internet

For information regarding Seagate products and services, visit www.seagate.com. Worldwide support is available 24 hours daily by email for your questions.

Presales Support:

Presales@Seagate.com

Technical Support:

DiscSupport@Seagate.com

Warranty Support:

<http://www.seagate.com/support/service/index.html>

mySeagate

my.seagate.com is the industry's first Web portal designed specifically for OEMs and distributors. It provides self-service access to critical applications, personalized content and the tools that allow our partners to manage their Seagate account functions. Submit pricing requests, orders and returns through a single, password-protected Web interface-anytime, anywhere in the world.

spp.seagate.com

spp.seagate.com supports Seagate resellers with product information, program benefits and sales tools. You may register for customized communications that are not available on the web. These communications contain product launch, EOL, pricing, promotions and other channel-related information. To learn more about the benefits or to register, go to spp.seagate.com, any time, from anywhere in the world.

Seagate Service Centers

Presales Support

Our Presales Support staff can help you determine which Seagate products are best suited for your specific application or computer system, as well as product availability and compatibility.

Technical Support

Seagate technical support is available to assist you online at support.seagate.com or through one of our call centers. Have your system configuration information and your "ST" model number available.

SeaTDD™ (+1-405-324-3655) is a telecommunications device for the deaf (TDD). You can send questions or comments 24 hours daily and exchange messages with a technical support specialist during normal business hours for the call center in your region.

Customer Service Operations

Warranty Service

Seagate offers worldwide customer support for Seagate products. Seagate distributors, OEMs and other direct customers should contact their Seagate Customer Service Operations (CSO) representative for warranty-related issues. Resellers or end users of drive products should contact their place of purchase or Seagate warranty service for assistance. Have your serial number and model or part number available.

Data Recovery Services

Seagate offers data recovery services for all formats and all brands of storage media. Our data recovery services labs are currently located throughout the world. . Additional information, including an online request form and data loss prevention resources, is available at <http://services.seagate.com/index.aspx>

Authorized Service Centers

Seagate Service Centers are available on a global basis for the return of defective products. Contact your customer support representative for the location nearest you.

USA/Canada/Latin America support services

For an extensive list of telephone numbers to technical support, presales and warranty service in USA/Canada/Latin America, including business hours, go to the "Contact Us" page on www.seagate.com.

Global Customer Support

Presales, Technical, and Warranty Support

Call Center	Toll-free	Direct dial
USA, Canada, and Mexico	1-800-SEAGATE	+1-405-324-4700

Data Recovery Services

Call Center	Toll-free	Direct dial	FAX
USA, Canada, and Mexico	1-800-475-01435	+1-905-474-2162	1-800-475-0158 +1-905-474-2459

Europe, the Middle East and Africa Support Services

For an extensive list of telephone numbers to technical support, presales and warranty service in Europe, the Middle East and Africa, go to the "Contact Us" page on www.seagate.com.

Asia/Pacific Support Services

For an extensive list of telephone numbers to technical support, presales and warranty service in Asia/Pacific, go to the "Contact Us" page on www.seagate.com.

Index

A

acoustics 16
Active mode 13
AFR 17
agency certification (regulatory) 17
altitude 14
ambient conditions 3
ambient temperature 10, 14
Annualized Failure Rate 17
Annualized Failure Rate (AFR) 17
areal density 9
ATA interface 27
ATA-standard commands 28
Australian C-Tick 18
autodetection 1
average seek time 10

B

BPI 9
breather filter hole precautions 22
burst 1

C

cable 24
cable select 1
cable-select option 23
cache 1
case temperature 14
CE mark 17
certification 17
Check Power Mode 28
commands 28
conducted noise 12
conducted RF immunity 16
configuring the drive 21
connector pins 27
connectors 24
Corrosive environment 19
CSA C22.2 (950) 17
CSEL 23
C-Tick 18
current profile 12
cycles 17

D

data-transfer rates 1
DC power 10
density 9
Device Configuration Freeze Lock 28
Device Configuration Identify 28

Device Configuration Restore 28
Device Configuration Set 28
Device Reset 28
diagnostic software 1, 34
dissipation 11
Download Microcode 28
drive diagnostics 10
drive monitoring 1
drive self-test 1, 34
DST 34
duty cycle 17

E

electrical fast transient 16
electromagnetic compatibility 17
Electromagnetic Compatibility Directive 17
electromagnetic immunity 16
electrostatic discharge 16
EMC compliance 17
EN 60950 17
enclosures 18
environmental specifications 14
EPRML 9
error-correction algorithms 1
errors 17
European Union 17
Execute Device Diagnostics 28

F

failure prediction 34
FCC verification 18
Features register 33
Flush Cache 28
Flush Cache Extended 28
Format Track 28
formatted capacity 8
frequency 16

G

guaranteed sectors 8

H

handling 21
heads 1
height 9
humidity 14

I

I/O data-transfer rate 9
I/O duty cycle 17
Identify Device 28
Identify Device command 30
Idle 28

Idle and Standby timers 13
Idle Immediate 28
Idle mode 13
Idle mode power 11
IEC950 17
Information Technology Equipment 17
Initialize Device Parameters 28
interface 9, 27
interface signals 27
interference 18
internal data-transfer rate OD 9
ISO document 7779 16

J

jumper settings 23

K

Korean RRL 18

L

LBA mode 8
length 9
logical geometry 8

M

maintenance 17
master 23
master/slave 1
Master/slave configuration 23
maximum temperature 14
Mean Time Between Failures 17
measurement locations 14
modes 27
monitoring 1
mounting the drive 21, 24
MTBF 17

N

noise 12
nominal power 3
nonoperating shock 15
nonoperating vibration 15
Nonrecoverable read errors 17

O

operating power and current 10
operating shock 15
operating vibration 15
orientation 24

P

physical characteristics 9

pins 27
PIO 27
power consumption 10
power dissipation 11
power management 13
power specifications 10
power-management modes 13
Power-on to Ready 10
power-on-hours 17
precautions 24
programmable power management 13

R

radiated RF immunity 16
radio and television interference 18
radio frequency 16
random track location 11
Read Buffer 28
Read DMA 28
Read DMA Extended 28
Read DMA without Retries 28
read errors 17
Read Log Ext 28
Read Multiple 1, 28
Read Multiple Extended 28
Read Native Max Address 28
Read Native Max Address Extended 28
Read Sectors 28
Read Sectors Extended 28
Read Sectors Without Retries 28
Read Verify Sectors 28
Read Verify Sectors Extended 28
Read Verify Sectors Without Retries 28
read/write power and current 10
Recalibrate 28
recording and interface technology 9
recording density 9
recording heads 1
recording method 9
register 33
relative humidity 14
reliability 17
resistance 12
resistive load 12
RF 16
RoHS 19

S

S.M.A.R.T. commands 34
S.M.A.R.T. Disable Operations 29
S.M.A.R.T. drive monitoring 1
S.M.A.R.T. Enable Operations 29
S.M.A.R.T. Enable/Disable Autosave 29
S.M.A.R.T. Execute Offline 29

- S.M.A.R.T. Read Attribute Thresholds 29
- S.M.A.R.T. Read Data 29
- S.M.A.R.T. Read Log Sector 29
- S.M.A.R.T. Return Status 29
- S.M.A.R.T. Save Attribute Values 29
- S.M.A.R.T. Write Log sector 29
- safety certification 17
- screws 24
- SeaTools 1, 34
- sectors 8
- Security Disable Password 28
- Security Erase Prepare 28
- Security Erase Unit 29
- Security Freeze 29
- Security Set Password 29
- Security Unlock 29
- Seek 29
- seek mode 10
- seek time 10
- servo electronics 11
- Set Features 29
- Set Features command 33
- Set Max Address 29
- Set Max Address Extended 29
- Set Multiple Mode 29
- shock 15
- signals 27
- single-track seeks 10
- slave 23
- Sleep 11, 29
- Sleep mode 13
- sound 16
- specifications 3
- spindle speed 9
- Spinup 11
- spinup power 10
- Standby 11, 29
- Standby Immediate 29
- Standby mode 11, 13
- Standby to Ready 10
- start/stop times 10
- start-stop cycles 17
- static-discharge precautions 21
- stop times 10
- subassembly 18
- support services 35
- surge immunity 16

T

- technical support services 35
- temperature 14
- temperature gradient 14
- timers 13
- TMR 1
- track density 9

- track-to-track seek time 10

U

- UL 1950 17
- Ultra ATA/100 24
- Ultra DMA 24

V

- vibration 15
- voltage 12
- voltage dips, interrupts 16
- voltage tolerance 12

W

- Warranty 17
- weight 9
- wet bulb temperature 14
- width 9
- Write Buffer 29
- Write DMA 29
- Write DMA Extended 29
- Write DMA Without Retries 29
- Write Log Extended 29
- Write Multiple 1, 29
- Write Multiple Extended 29
- Write Sectors 29
- Write Sectors Extended 29
- Write Sectors Without Retries 29



Seagate Technology LLC
920 Disc Drive, Scotts Valley, California 95066-4544, USA
Publication Number: 100440155, Rev. E, Printed in U.S.A.