

Maxtor[®]



MAXTOR SHARED STORAGE^a II

User's Guide



MAXTOR SHARED STORAGE II USER'S GUIDE

Contents

Windows Installation

Introduction	1
About this Guide	1
Components	1
Included in Package	2
System Requirements	2
Handling Precautions	2
Maxtor Product Support	2
Installing the Shared Storage II ...	3
Step 1 - Connect the Drive	3
Step 2 - Power up the Drive	4
Step 3 - Setup the Drive	5
Using the Shared Storage II	6
Using EasyManage	6
SimpleView™	6
Create User Account	7
Settings	10
Backup	12
Backup File Management	12
Restore	14
OneTouch Status Icons	15
Using Media Server	16
Storing Audio	17
Shutting Down Your Shared Storage II ..	17
Resetting Your Shared Storage II	17
Security Lock	18
Media Serving	18

Macintosh Installation

Introduction	20
About this Guide	20
Components	20
Included in Package	21
System Requirements	21
Handling Precautions	21
Maxtor Product Support	21
Installing the Shared Storage II ...	22
Step 1 - Connect the Drive	22
Step 2 - Power up the Drive	23
Step 3 - Setup the Drive	24
Using the Shared Storage II	25
Using EasyManage	25
Create and Use Shared Folders	25
Creating Shared Folders	25
Drag and Sort™	28
Backup Settings	29
Editing Backup Settings	30
Advanced Settings	30
SimpleView™ Storage and Backup	33
Using Media Server	33
Storing Audio	34
Shutting Down Your Shared Storage II ..	34
Resetting Your Shared Storage II	34
Security Lock	35
Media Serving	35

Web User Interface

Accessing the Web UI	37
Run Set-up Wizard	38
Accounts Management	39
Shared Folders Management	41
Manage Digital Photos, Music, Video ..	43
Shared Folder Backup	43
Advanced Settings	45
Network Settings	46
System Maintenance	47
Configure Your USB Devices	48
System Status	49
Using External USB Drives	50
Using USB Printers	50

MAXTOR SHARED STORAGE II WINDOWS INSTALLATION

Introduction

Thank you for selecting the Maxtor Shared Storage II Drive.

Connecting this storage solution to your network in a home or small office is a simple and economical way for users to share and backup files. Your new Maxtor Shared Storage II drive offers a winning combination of capacity, simplicity of use and helpful software features that automate configuration, privacy and more. The simple installation allows you to start using your drive as quickly as possible. You can also change settings on your drive at any time, and manage user access through web browsers.

Shared Storage II Features

Instantly add storage to your network, back up files across every compatible computer on your network, and stream music, videos and photos from your drive to your home entertainment system.

Simple Installation and Setup

- Automatically configure the drive to your network
- Manage the drive using our simple user interface
- Connect and share additional hard drives using the drive's 2 USB ports
- Easily store and share access to files, photos, music and videos
- Organize files automatically using Drag and Sort™
- Give users full access to public folders, while keeping others private
- Get backup and storage status for all users with SimpleView™
- Back up user files/folders to an external USB drive
- Protect data on all of your networked PCs using Maxtor® Backup
- Playback of Videos, Music and Photos
- Use our media streaming feature to play digital photos, music and video on a networked home entertainment system - even without turning on your computer
- Connect automatically through a UPnP™ AV compatible digital media adapter

About this Guide

The following symbols and conventions are used in this guide:

Bold Used for menu, command, and keyboard selections you make and screens you will see.

Italics Used for emphasis and to identify new terms.

Components

Before installing, review the solution features in Figure 1.

FIGURE 1 SOLUTION FEATURES

1. Status Lights
2. Power Switch
3. Power Connector
4. USB 2.0 Ports
5. Ethernet Port
6. Security Lock

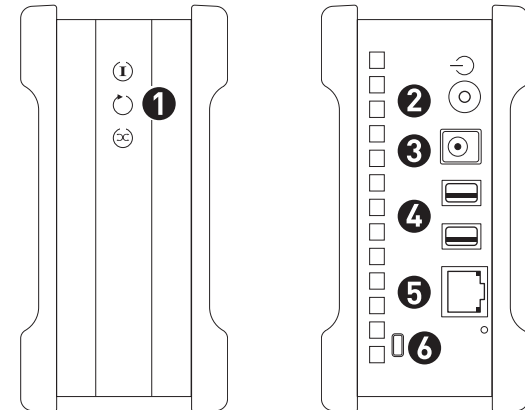

MAXTOR SHARED STORAGE II WINDOWS INSTALLATION

FIGURE 2 INCLUDED IN PACKAGE

1. Backup Solution
2. Power Adapter
3. Ethernet Cable
4. EasyManage CD

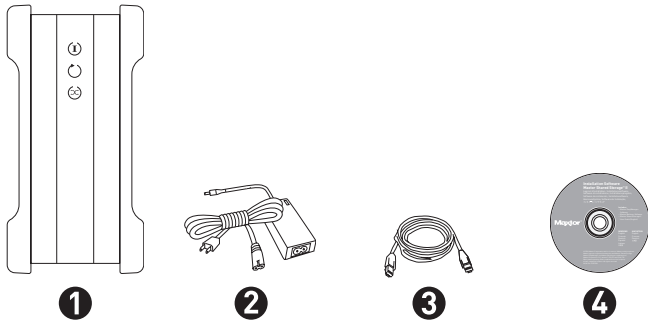

System Requirements

- Wired or wireless router with an available 10/100/1000 Ethernet port
- Pentium III, 500 Mhz equivalent processor or higher
- Windows® 2000 Professional, XP Professional, or Media Center
- 256MB RAM (512MB recommended) or more as required by operating system
- Internet connection (for system updates)
- Internet Explorer 6.0 or higher (for management interface of Shared Storage II)
- UPnP certified Digital Media Adapter (if using Media Serving)
- CD-ROM/DVD-ROM drive

Handling Precautions

Please handle your new Maxtor Shared Storage II with care!

Follow the precautions listed here or you could damage your drive and void the product warranty. Review the Maxtor Limited Warranty for more information.

Follow these precautions to prevent data loss

- Do not bump, move or drop the drive while in operation.
- Do not remove the interface cable or power cord without first disconnecting the drive properly through the operating system.
- Do not set any liquids or drinks on or near the drive. Liquids will damage the internal electronics.
- Do not open the drive enclosure. This can cause loss of data and will void the product warranty.

Maxtor Product Support

Maxtor Corporation provides a comprehensive product support section on its web site, including the latest software drivers, product specifications, a complete troubleshooting section, and the Maxtor Knowledge Base.

Maxtor USA Support

Visit www.maxtorkb.com for the following information:

- **Search the Hard Drive Knowledge Base**
We store all resolved problems and FAQ's in our knowledge base. Search by product, category, keywords, or phrases.
- **My Stuff**
Login to modify or view your FAQ update notifications or update your personal profile.
- **Most Popular Help Topics**
Top five most frequently asked questions.
- **Software Download**
Download installation and diagnostic programs for your hard drive or external storage device.

Maxtor Worldwide Support

Visit www.maxtor.com and click **worldwide support** or **contact us** for product support outside of the USA.

MAXTOR SHARED STORAGE II WINDOWS INSTALLATION

Installing the Shared Storage II

Step 1 – Connect the Drive

The Maxtor Shared Storage II connects to your computer with a Cat5 Ethernet cable.

Connecting the Ethernet Cable

1. Plug one end of the Ethernet cable into your network, router or switch.
2. Plug the other end of the Ethernet cable into the Ethernet port on your Shared Storage II drive.
3. Once connected, the Ethernet status LED(s) located on either side of the Ethernet port will illuminate:
 - If connected through a 10/100 cable/router – the Green LED on the left side of the connector will show activity when the Shared Storage Drive is powered on. This LED will also illuminate when connected to a Gigabit cable/router too.
 - If connected through a Gigabit cable/router – the Amber LED on the right side of the connector will show activity when the Shared Storage Drive is powered on.

FIGURE 3 CONNECTING THE ETHERNET CABLE

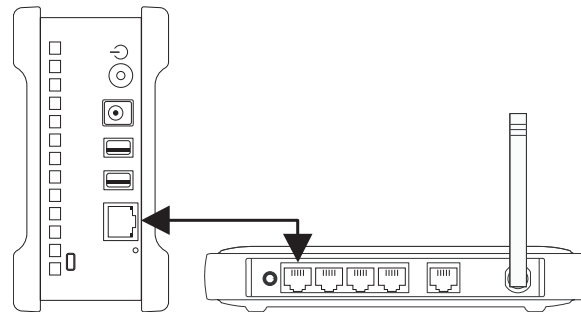

Connecting the Power

1. Plug the round female connector from the power adapter into the drive's power connector.
2. Plug the female connector on the power cord into the power adapter.
3. Plug the standard electrical plug from the power adapter into your power source.

FIGURE 4 CONNECTING THE POWER

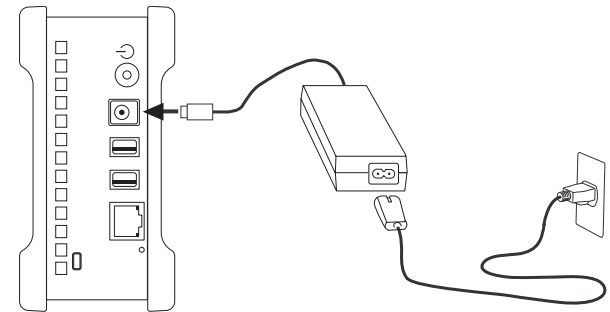

MAXTOR SHARED STORAGE II WINDOWS INSTALLATION

Step 2 – Power up the Drive

1. Press the round black button on the back panel of your Maxtor Shared Storage Drive. The green LED (light) will illuminate in the center of the power button.

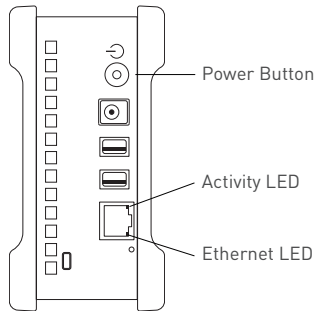

2. Your drive will now start. The startup process can take up to one minute to complete.

Shared Storage Drive Power/Status LED Definitions

Various LED activity will appear on your Shared Storage II Drive when power is applied. The following tables define the meaning/status of each LED on the back and front panels:

Back Panel LEDs

LED	Definition	Status
Power LED (located in center of the power button)	Power switch	Illuminated – Power On Not Illuminated – Power Off
Ethernet LED (located on bottom side of Ethernet connector)	Shows if the drive is connected through a 10/100 or a 1 Gb Ethernet connection. Left Green – 10/100 Mbps Ethernet connectivity Left Amber – 1 Gbps Ethernet connectivity	Illuminated – Power On Blinking – Network communication is occurring Not Illuminated – Power Off
Activity LED (located on top side of Ethernet connector)	A flashing Activity LED indicates that the network connection is functional and that packets are being transmitted or received.	

Front Panel LEDs

LED	Definition	Status
Top	Power Activity	Illuminated – Power On Blinking – Drive is either powering up or shutting down Not Illuminated – Power Off
Center	Hard Disk Activity	Illuminated – Power On Blinking – Data is being transferred to/from the drive Not Illuminated – Power Off
Bottom	Network Activity	Illuminated – Power On Blinking – Network communication is occurring Not Illuminated – Power Off

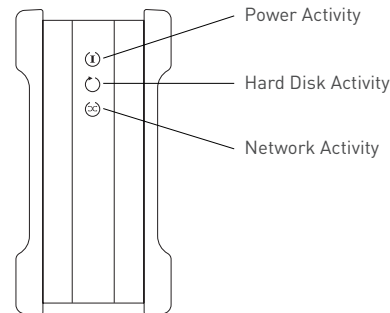

MAXTOR SHARED STORAGE II WINDOWS INSTALLATION

Step 3 – Set up the Drive

1. Insert the Maxtor Shared Storage II Installation Software into your CD-ROM drive. The Select Language window will display.
Note: In the event that the CD does not autorun, click **Start → Run**. Browse to the drive letter associated with the EasyManage CD. Click on **Setup**, click **Open**, and then click **OK**.
2. The **Select Language** window opens. Choose your **language** (e.g., English).
3. From the main menu, click **Install Software**.
4. You will be asked if you wish to install the software. Click **OK**.
5. The **License Agreement** screen will appear. Click **Yes**.
6. The **Choose Destination Location** screen will appear. If you wish to change the location of the installation, you may do so by clicking the Browse button and selecting a new location. Click **Next**.
7. The **Setup Status** screen will appear as the software is installed, followed by the **InstallShield Wizard Complete** screen when the installation is complete. Click **Finish** to restart your system.
8. After system restart, EasyManage will discover Shared Storage Drive(s) on you network segment.
Note: In the event that No Shared Storage Drives were found, please refer to the Help File for available troubleshooting tips.

A Note About EasyManage

EasyManage is an all encompassing application that will, under specific conditions, allow you to manage both Maxtor OneTouch III and Shared Storage Drive products through one single interface.

This simply means that you can use EasyManage in conjunction with these products provided one of the following software packages is installed:

- Maxtor OneTouch III USB 2.0
- Maxtor OneTouch III FireWire 400/USB 2.0
- Maxtor OneTouch III FireWire 800/FireWire 400/USB 2.0
- Maxtor OneTouch III Turbo Edition
- Maxtor OneTouch III Mini Edition

Granted, you can use these software packages completely separate from EasyManage. However, it is suggested that you use the EasyManage application with all of these products.

Note: Please refer to Maxtor's Knowledge Base for examples and more information.

9. Once detected, a window displays informing you that your Shared Storage drive has no security password set for the administrative function.

To set a password for the drive, click **Manage**. This will launch the Web User Interface (Web UI). Follow the onscreen prompts in you browser to configure your Shared Storage Drive.

Note: See "The Web UI" later in this guide for details on using the Maxtor Shared Storage Web UI. Run Set-up Wizard for more information on configuring these settings.

10. When finished, close your browser to return to the Storage Manager's Settings screen, and then click the **Home** button.

MAXTOR SHARED STORAGE II WINDOWS INSTALLATION

Using the Shared Storage II

Using EasyManage

Home



The EasyManage Home window provides access to the following:

Search for Shared Storage Drives



When selecting this option, EasyManage discovers Shared Storage Drives located on your network segment. When detected, the following information is displayed:

- Hostname (e.g., MSS-000155)
- IP Address
- MAC Address
- Mounted Share
- Drive (letter assigned to the Mounted Share – e.g. Z:)

Note: Mounted Share and Drive entries will be blank unless a user account is connected.

Detection of Shared Storage Products

EasyManage can detect all Maxtor Shared Storage Drive products located on your network segment. If you select a Shared Storage or Shared Storage Plus Drive, EasyManage will display this image:



If you select a Shared Storage II Drive, EasyManage will display this image:



Note: In the event that no Shared Storage Drives were found, please refer to the Help File for available troubleshooting tips.

SimpleView™

When selected, SimpleView provides the following information:

- **Space Used** - Total size of all user's files
- **Last Backup** - Date of user's last backup
- **Backup Status** - Success of user's last backup. This information is displayed via backup status indicators (icons) in the Backup Status column.

Backup Status Indicators Definitions

Color	Status	Meaning
	Complete	All files successfully backed up
	Incomplete	Some files backed up
	Failed	No files backed up

MAXTOR SHARED STORAGE II WINDOWS INSTALLATION

Backup Log File

You can see the details of a backup by reading the log file. To view the log file, click the colored status indicator in the Backup Status column.

Depending on your operating system, you will be prompted with Open File window. If so, click the **Open** button.

This will launch your system's text editor (e.g., Notepad) and show you information regarding the backup in question. Below is an excerpt from a log file:

```
*****  
Friday, June 02, 2006, at 09:15  
\\MSS-000155\Maxtor\My Backup Destination is not accessible  
\\MSS-000155\Maxtor\My Backup Destination is not accessible  
\\MSS-000155\Maxtor\My Backup Destination is not accessible
```

Create User Account

This feature gives the admin the capability to create user accounts on the Shared Storage drive. The admin can create Public or Private user accounts and further customize these accounts for either Home or Business use.

Account Types

Public

With a public account, all of your files are accessible to anyone who has an account on the Shared Storage Drive.

Private

With a private account, all of your files are password-protected except for those that you place in your "public" folder to share with others.

Home and Business Folders

You can choose a set of folders appropriate for Home or Business use. The folders created are listed below.

Home Folders

Folder	Appropriate for
My Backup	Backed-up files
My Documents	Word processing files
My Library	Electronic books
My Movies	Home videos
My Music	Digital music collection
My Photos	Digital photos and artwork
My Sites	Web pages
My Software	Software storage
Public	Sharing files with others

Business Folders

Folder	Appropriate for
My Backup	Backed-up files
My Documents	Word processing files
My Multimedia	Audio and video files
My Photos	Digital photos and artwork
My Presentations	Presentation files
My Projects	Project files
My Sites	Web pages
My Spreadsheets	Spreadsheet files
My Software	Software storage
Public	Sharing files with others

MAXTOR SHARED STORAGE II WINDOWS INSTALLATION

Naming Conventions

- A User Name may contain 1 - 20 characters
- Users with a Private user account can have a Password that contains 1 - 32 characters
- Both the User Name and Password may contain letters, numbers, and underscores “_”, but no spaces or symbols can be used

To Create a Public Home User Account

1. From the EasyManage home page, click the **Create a user account** button.



2. The **Create a user account** screen opens. Click on the **Public** and **Home** buttons.
3. In the **Name** field, type the **name** for the user.
4. Click the **Create** button.
5. At this point, the user is created. A status bar shows the creation of the account. This process may take awhile.
6. When finished, you will be notified that a folder has been created for the user. A shortcut icon (by default, this shortcut maps to Drive Z: - or the next available drive letter) will appear on the system's desktop for the user.



7. Click **Open** to use the folder right away.
8. Click **Done** to return to the EasyManage Home Window.

Note: The Mounted Share and Drive fields, located in the EasyManage Home window, are now populated with the user account's information.

To Create a Public Business User Account

1. From the EasyManage home page, click the **Create a user account** button.



2. The **Create a user account** screen opens. Click on the **Public** and **Business** buttons.
3. In the Name field, type the **name** for the user.
4. Click the **Create** button.
5. At this point, the user is created. A status bar shows the creation of the account. This process may take awhile.
6. When finished, you will be notified that a folder has been created for the user. A shortcut icon (by default, this shortcut maps to Drive Z: - or the next available drive letter) will appear on the system's desktop for the user.



7. Click **Open** to use the folder right away.
8. Click **Done** to return to the EasyManage Home Window.

Note: The Mounted Share and Drive fields, located in the EasyManage Home window, are now populated with the user account's information.

MAXTOR SHARED STORAGE II WINDOWS INSTALLATION

To Create a Private Home User Account

1. From the EasyManage home page, click the **Create a user account** button.



2. The Create a user account screen opens. Click on the **Private** and **Home** buttons.
3. In the Name field, type the **name** for the user.
4. In the fields provided, enter a **password** and confirm the password.
5. Click the **Create** button.
6. At this point, the user is created. A status bar shows the creation of the account. This process may take awhile.
7. When finished, you will be notified that a folder has been created for the user. A shortcut icon (by default, this shortcut maps to Drive Z: - or the next available drive letter) will appear on the system's desktop for the user.



8. Click **Open** to use the folder right away.
9. Click **Done** to return to the EasyManage Home Window.

Note: The Mounted Share and Drive fields, located in the EasyManage Home window, are now populated with the user account's information.

To Create a Private Business User Account

1. From the EasyManage home page, click the **Create a user account** button.



2. The Create a user account screen opens. Click on the **Private** and **Business** buttons.
3. In the Name field, type the **name** for the user.
4. In the fields provided, enter a **password** and confirm the password.
5. Click the **Create** button.
6. At this point, the user is created. A status bar shows the creation of the account. This process may take awhile.
7. When finished, you will be notified that a folder has been created for the user. A shortcut icon (by default, this shortcut maps to Drive Z: - or the next available drive letter) will appear on the system's desktop for the user.



8. Click **Open** to use the folder right away.
9. Click **Done** to return to the EasyManage Home Window.

Note: The Mounted Share and Drive fields, located in the EasyManage Home window, are now populated with the user account's information.

MAXTOR SHARED STORAGE II WINDOWS INSTALLATION

Connect to a User Account

This feature of EasyManage allows you to select the user account's share that you wish to use on your PC.

1. Click the **Connect to a user account** button.



2. The **Connect to a user account** window is displayed. At this point, EasyManage identifies all user accounts on the Shared Storage drive and lists them in the **Name** field.
3. Click on the **triangle** to the right of the **Name** field and select a **name** from the drop-down menu.
4. If you are selecting a **Private Account**, type the **password** for the user in the Password field.
5. Click the **Mount** button.
6. When finished, you will be notified that you can access the folder for the selected user. A shortcut icon (by default, this shortcut maps to Drive Z: - or the next available drive letter) will appear on the system's desktop for the user.



7. Click **Open** to use the folder right away.
8. Click **Done** to return to the EasyManage Home Window.

Note: The Mounted Share and Drive fields, located in the EasyManage Home window, are now populated with the user account's information.

What's New?

Click on this button to go to www.maxtorsolutions.com. There you can find more information on Shared Storage II Drive.

Maxtor Support

Click on this button and your browser will launch to the home page for Maxtor's Knowledge Base. There you can find comprehensive articles related to troubleshooting, FAQs and other information for the Shared Storage drive and other Maxtor products.

Settings



Drag and Sort

The Drag and Sort feature automatically sorts files into a set of folders inside your personal folder or the public folder. Every time you drag files to your Shared Storage Drive, each file is sorted into the appropriate folder based on its file type.

By default, the Drag and Sort feature is turned **On** and files will sort into the **My Personal** folder.

To Disable Drag and Sort Settings

1. Open **EasyManage** and click on the **Settings** button.
2. From the **Settings** screen, click **Drag and Sort**.
3. Click the **Off** button and click **Apply**.
4. At this point, the Drag and Sort feature is turned **Off** and you are returned to the Settings window.

To Enable Drag and Sort Settings

1. Open **EasyManage** and click on the **Settings** button.
2. From the **Settings** screen, click **Drag and Sort**.
3. Click the **On** button and click **Apply**.
4. At this point, the Drag and Sort feature is turned **On** and you are returned to the Settings window.

MAXTOR SHARED STORAGE II WINDOWS INSTALLATION

To Sort Files into Our Public Folder

1. Open **EasyManage** and click on the **Settings** button.
2. From the **Settings** screen, click **Drag and Sort**.
3. Click the **Sort files into “Our” public folder** button and click **Apply**. At this point, the Drag and Sort feature is configured to copy files to “Our” public folder and you are returned to the Drive Management window.

Sorted File Types

A complete list of default, sorted file types can be found via the Help menu. Click the “**Which file types work and how are they sorted?**” link for more information. The Sorted File Types list can be configured to meet your needs.

Advanced Web Page

The Advanced Web Page feature launches the Shared Storage Drive’s Web User Interface (aka Web UI).

Note: You must login as the admin user to use the Web UI.

To access this feature:

1. Open **EasyManage** and click on the **Settings** button.
2. From the **Settings** screen, click **Advanced Web Page**. This will launch the Web UI. If prompted, type the **User name** and **Password** to authenticate.

The admin user can select this option to configure the Shared Storage Drive’s:

- Language
- Network Time Protocol
- Date/Time Format
- Date
- Time
- Computer Name
- Workgroup Name
- Password

Note: See “The Web UI” later in this guide for details on using the Maxtor Shared Storage Web UI. Run Set-up Wizard for more information on configuring these settings.

Folder Tags

By default, this feature adds a special icon to each folder on your computer that is set to be backed up to the Shared Storage Drive.



Example of a Folder Tag denoted by the blue circle with a check.

To Disable Folder Tags

1. Open EasyManage and click on the **Settings** button.
2. Click on **Folder Tags**.
3. From the **Settings: Folder Tags** window, click the **Off** button.
4. Click **Apply to Disable Folder Tags**.

To Re-enable Folder Tags (when it has been shut off)

1. Open **EasyManage** and click on the **Settings** button.
2. Click on **Folder Tags**.
3. From the **Settings: Folder Tags** window, click the **On** button.
4. Click **Apply to Enable Folder Tags**.

MAXTOR SHARED STORAGE II WINDOWS INSTALLATION

Shared Folder Backup

This option will launch your browser and open the Shared Folder Backup portion of the Web UI. From this, you can:

- Format an external USB drive for use as a backup for Shared Folders located on the Shared Storage Drive
- Backup and Restore data

Note: See “The Web UI” later in this guide for details on using the Maxtor Shared Storage Web UI - Shared Folder Backup for more information on configuring these settings.

Backup



From this screen, you can:

- Set a backup so that local files from your PC will backup to the Shared Storage Drive
- Begin an immediate backup of your selected files/folders from your PC to the Shared Storage Drive
- Perform file maintenance tasks that delete historical file versions from the Shared Storage Drive and remove files from the shared Storage Drive if they are no longer on your PC

To Setup a Backup

1. Open **EasyManage** and click the **Backup** button.
2. The Backup: Settings Part 1 of 2 – Select Folders window opens. Check the boxes associated with the **files** and or **folders** you want to back up and click **Next**.
3. The Backup: Settings Part 2 of 2 – Schedule Days/Time window opens. By default, your selected files and/or folders will be backed up daily at 10:00 pm. Click **Finish** to continue.
4. The Backup Files to My Shared Storage Device Window opens. To launch your first backup, click **Back Up Now**. The backup will launch copying selected files/folders from your PC to your User Account’s My Backup folder on the Shared Storage Drive. Backup times may vary pending on how much data has to be copied.

Edit My Backup Settings

1. Open **EasyManage** and click on the **Backup** button.
2. The **Backup: Settings** window opens. Check the boxes associated with the **files** and or **folders** you want to back up and click **Next**.
3. A second **Backup: Settings** window opens. By default, your selected files and/or folders will be backed up daily at 10:00 pm. Check the **days/time** that you wish to run your edited backup and click **Finish**.
4. The **Backup Files to My Shared Storage Device** window opens. To launch your first backup, click **Back Up Now**. The backup will launch copying selected files/folders from your PC to your User Account’s My Backup folder on the Shared Storage Drive. Backup times may vary pending on how much data has to be copied.

Backup File Management

Edit Historical Versions

This option allows you to change the number of Historical File Versions you wish to store on your Shared Storage Drive. You can select between 1 – 10 Historical Versions to save. By default, 5 historical versions of each file are stored.

1. Open **EasyManage** and click on the **Backup** button.
2. The **Backup Files to My Shared Storage Device** window opens. Click **Backup File Management**.
3. Click **Edit** to open the **Advanced Settings** window.
4. Click on the **down arrow** of the **Historical Versions** dropdown menu.
5. Choose the **number of Historical Versions** you wish to backup (between 1 – 10) and click **Save** to return to the Backup File Management window.

MAXTOR SHARED STORAGE II WINDOWS INSTALLATION

Delete Historical Versions

This option will delete all but the most recent Historical File Versions from your user account's My Backup folder.

1. Open **EasyManage** and click on the **Backup** button.
2. The **Backup Files to My Shared Storage Device** window opens. Click **Backup File Management**.
3. Click **Delete**.
4. A confirmation window opens asking you to confirm the deletion.

Note: All Historical File Versions will be deleted except for the most recent if you continue.

Click **Yes** to delete the Historical File Versions.

5. Click **OK** to return to the Backup File Management window.

Clean Up Deleted Files

This option will remove all files from your user account's My Backup folder if they have been deleted from your PC.

1. Open **EasyManage** and click on the **Backup** button.
2. The **Backup Files to My Shared Storage Device** window opens. Click **Backup File Management**.
3. Click **Clean Up**.
4. A confirmation window opens asking you to confirm the deletion.

Note: All files will be deleted from the user account's My Backup folder if you continue.

Click **Yes** to delete these files.

5. Click **OK** to return to the Backup File Management window.

Automatic Backups On/Off

You can turn Off/On Automatic Backups on your Shared Storage Drive. Automatic Backups are beneficial because you don't have to remember to backup your data regularly. However, some users like the flexibility of managing their backups manually.

To Turn Automatic Backups Off

1. Open **EasyManage** and click on the **Backup** button.
2. The **Backup Files to My Shared Storage Device** window opens. In the upper-right corner of the window you will see that, by default, Automatic Backups is turned On. Click **Off** to continue. At this point, the Automatic Backup feature is disabled.

Note: When the Automatic Backup feature is turned Off, all backup functionality must be done manually. To manually launch a backup:

- Open **EasyManage**, click on the **Backup** button.
- The **Backup Files to My Shared Storage Device** window opens. To manually launch a backup, click **Back Up Now**.

or

- Click on the **OneTouch Status** icon in the System Tray and select **Back Up Now** from the menu

To Turn Automatic Backups On

1. Open **EasyManage** and click on the **Backup** button.
2. The **Backup Files to My Shared Storage Device** window opens. In the upper-right corner of the window you will see that Automatic Backups are turned Off. Click **On** to continue. At this point, the Automatic Backup feature is enabled and you can schedule backups.

MAXTOR SHARED STORAGE II WINDOWS INSTALLATION

Restore



Differences Between Restore Methods

Restore Historical Versions of Individual Backed-up Files

Choosing this option allows you to restore an individual historical version of a file, based on the date it was backed up. The number of historical versions available is based on the number selected in the Backup File Management option under Edit Historical Versions. You can select between 1 – 10 Historical Versions to save. By default, 5 historical versions of each file are stored.

Restore Most Recent Files and Folders

Choosing this option will open the “My Backup” folder inside the folder for your user account on the Shared Storage drive. You can then restore multiple files and folders by clicking and dragging them to wherever you want to put them.

Restore Historical Versions of Individual Backed-up Files

1. Open **EasyManage** and click the **Restore** button.
2. From the **Restore a Backup from my Storage Device** window, click **Restore historical versions of individual backed-up files**.

Select a File

- Click the plus “+” sign next to your **Shared Storage Drive** to reveal the folders stored inside the folder for your account.
- Click the plus “+” sign next to the **My Backup** folder and select the file you would like to restore by clicking its checkbox.

Select a Version

Click the checkbox next to the version you would like to restore. Versions are listed by date.

Restore to Folder

Original	Restores files to its original folder on your computer
Temporary	Restores file to the following folder: C:\MyDocuments\YourUserName\MSS Restore

Note: “YourUserName” is your account Name.

3. Click **Restore** to restore files to your computer.

Restore Most Recent Files and Folders

1. Open **EasyManage** and click on the **Restore** button.
2. From the **Restore a Backup from my Storage Device** window, click the **Restore most recent files and folders** button.
3. This will launch a window showing the root directory structure of the My Backup folder for the user connected to the Shared Storage Drive. To restore files, simply browse to the file(s) location and drag and drop (copy and paste) files/folders from the Shared Storage Drive to your computer.

Media Server



This option will launch your browser and open the Manage Digital Photos, Music, and Video portion of the Web UI.

Note: See “The Web UI” later in this guide for details on using the Maxtor Shared Storage Web UI - Manage Digital Photos, Music, and Video for more information on configuring these settings.





MAXTOR SHARED STORAGE II WINDOWS INSTALLATION

OneTouch Status Icons

The OneTouch Status Icon can:

- Report the connectivity of your Shared Storage Drive and or the status of the last backup
- Can be used for accessing certain EasyManage software features

Color Definitions

Icon	Meaning
Gray 	No Shared Storage Drive is connected.
Green 	Last backup completed successfully.
Yellow 	Last backup completed with errors.
Red 	Last backup failed.
Blue 	Backup needs to be configured.

Features

Access to User Shared Folder

This feature will open up the connected user share in an explorer window.

1. Click on the **OneTouch Status icon**.
2. Select the share displayed (e.g., Public) at the top of the menu. An explorer window opens showing you the contents of the share's files and folders.

Backup Now

This feature will launch an immediate backup of selected files and folders to the connected user account's My Backup folder

1. Click on the **OneTouch Status icon**.
2. Click on **Back Up Now**. An immediate backup will be performed. You will notice that the OneTouch Status Icon will turn yellow (denoting backup activity) during the backup process.

Change Account

This feature will launch the EasyManage's Connect to a user account window.

Note: See "Connect to a User Account" on page 10 for more information regarding the use of these options.

Backup Settings

This feature opens EasyManage's Backup My Files to My Shared Storage Device window. From which you can Edit Backup Settings, perform Backup file Management tasks (e.g., Edit Historical Versions, Delete Historical Versions, Clean Up files), launch immediate backups and/or Turn On/Off Automatic Backups.

Note: See "Edit My Backup Settings" on page 12 for more information regarding the use of these options.

Restore

This feature opens EasyManage's Restore window. From which you can Restore Historical Versions of Individual backed Up Files or Restore Most Recent Files and Folders

Note: See "Restore" on page 14 for more information regarding the use of these options.

MSS Settings

This feature opens EasyManage's Settings window. From which you can configure Drag and Sort, launch the Web UI, configure Folder Tags, review backup status and disk usage with SimpleView, and launch the Web UI's Shared Folder Backup options.

Note: See "Settings" on page 10 for more information regarding the use of these options.

MAXTOR SHARED STORAGE II WINDOWS INSTALLATION

Exit

This feature exits (closes and removes) the OneTouch Status icon from your System Tray. To exit OneTouch Status:

1. Click on the **OneTouch Status icon** and select **Exit** from the menu.
2. A window appears asking you to confirm this task. Click **Yes** to continue. This closes the OneTouch Status application. In the event that the OneTouch Status Icon still appears in the System Tray, simply move your mouse over it to remove it.

To Re-open the OneTouch Status Application

1. Click **Start → Programs** (all Programs with Windows XP) **→ Maxtor → OneTouch Status**. The OneTouch Status application will load the icon back into the System Tray.

Using Media Server



Use Media Server to Manage your Digital Photo, Music and Video Collection

If you have a networked home entertainment system, you can use Media Server to manage your digital photo, music and video collection on your Shared Storage Drive and use it with your entertainment system. Media Server can even search your iTunes Music folder for music and video files.

Media Server recognizes files in the following folders on your Shared Storage Drive: Our Photos, Our Music, Our Movies, My Photos, My Music, My Movies or My Multimedia. By placing your files in these folders, they will automatically be available for use with your entertainment system. In order to use Media Server, your entertainment system will need to be compatible with UPnP (Universal Plug and Play).

To enable Media Server on your Shared Storage Drive, click the Media Server button in the main EasyManage screen.

To Enable Media Server

1. From the EasyManage main menu, click the **Media Server** button.
2. This will launch your browser. When prompted, type the **User Name** and **Password** to authenticate.
3. Click **Login**.

This will launch your browser directly to the Manage Digital Photos, Music, and Video page.

Note: See “The Web UI” later in this guide for details on using the Maxtor Shared Storage Web UI - Manage Digital Photos, Music, and Video for more information on configuring these settings.

MAXTOR SHARED STORAGE II WINDOWS INSTALLATION

Storing Audio

Using your computer as an audio jukebox is a very popular application. This allows you to store and play thousands of your favorite songs. You can also create and manage an audio library from your Maxtor Shared Storage II.

Shutting Down Your Shared Storage II Drive

To Shut Down Your Drive

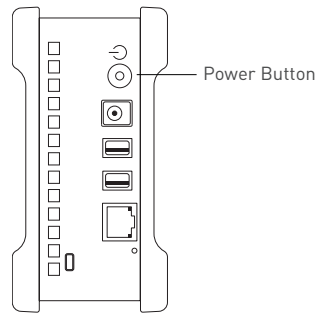

1. Press the round black button on the back panel of your Maxtor Shared Storage Drive. Upon doing so, the power status button on the front panel of the Shared Storage Drive will blink rapidly.

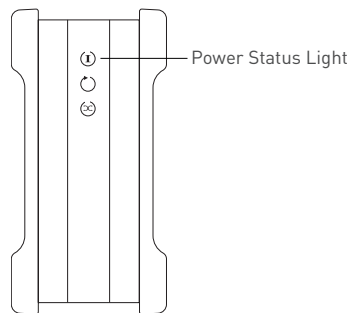

The power down sequence will take 1 – 10 seconds to complete. When properly shutdown, all LEDs on the front and back will no longer be illuminated.

Resetting Your Shared Storage II Drive

If you can not access your drive after moving it to another network, turning it on after it has been off for a period of time, or if you have forgotten/lost the admin password it may need to be reset.

To Reset Your Drive

1. With the drive turned on, use the tip of a pen or paperclip, then press and hold the reset button on the back of your drive. After a few seconds, the drive will reboot.

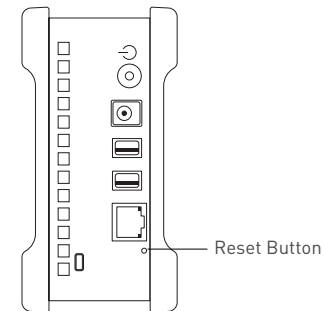

2. The power status LED will return to a blink state of about 1 second between blinks. The reset is complete and your drive is ready for use.

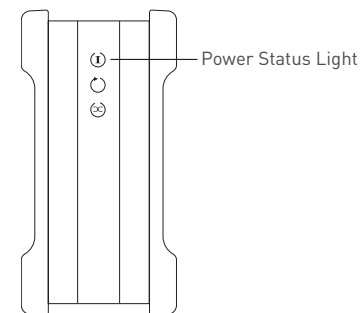

After Resetting Your Drive

- The admin password will be removed
- The computer name will reset back to its default name (Example: MSS-000155)
- The workgroup name will be reset to MSHOME

MAXTOR SHARED STORAGE II WINDOWS INSTALLATION

Security Lock

Your new Maxtor Shared Storage II includes a security locking slot on the back of the drive. The slot is compatible with most security locking cables.

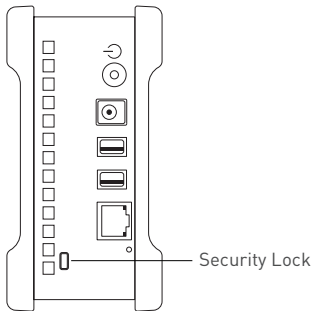

Media Serving

With the Shared Storage Drive's Media Serving capabilities, you can view videos or photos and listen to music on your home entertainment center without ever turning on your computer. The Media Server feature is disabled by default on the Shared Storage Drive.

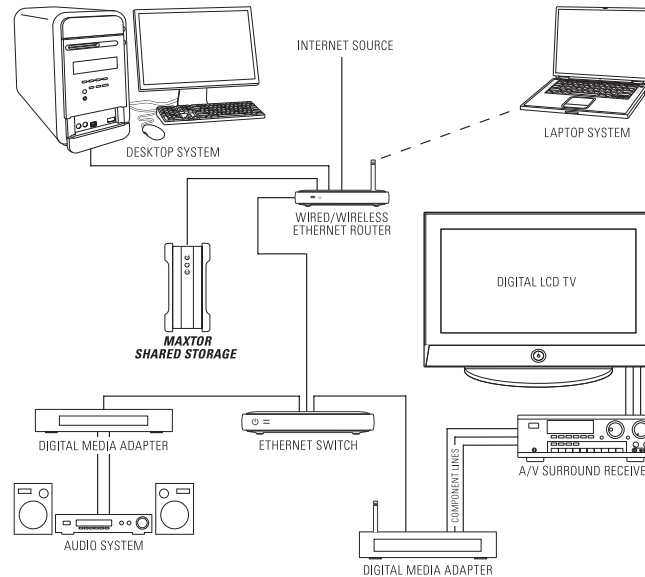

Once your Shared Storage Drive is properly connected to your network, you can copy music, movies, or videos directly to it. Next, connect an UPnP™ AV compatible digital media adapter (DMA) through your router, and your home network becomes a home entertainment center.

MAXTOR SHARED STORAGE II WINDOWS INSTALLATION

Considerations for Home Media Networks

- Some data may not be available for access for up to two (2) hours after being copied to the Shared Storage Drive. To obtain immediate access to these media files, click the Refresh button located in Web UI.
- Take a survey and note all of the wireless devices in your household (e.g., radio's, stereo's, speakers, phones, cell phones, microwave ovens, alarms, etc.).
- Use of a hand held WiFi detector will help determine strength and weakness of WiFi signals in your home.
- Be suspicious of any wireless devices in the same general area and remove them from the WiFi paths of your routers and media players.
- In some cases, firewalls may need to be disabled and re-enabled.
- Most wireless devices broadcast a wireless frequency by default. Check the documentation of your wireless media players for configuration (WEP) settings.
- Check that your wireless router (WEP) security settings will allow detection and connection of new devices.
- Try moving your media player within a couple of feet of your wireless router for configuration and connection.
- When configuring and detecting wireless devices, keep an Ethernet cable handy to hard wire the devices together for diagnosis.
- If you continue to have problems with your WiFi connection dropping off line, consider hardwiring the devices with Cat5e Ethernet cabling.
- If you're still having detection issues, reset all network devices by physically unplugging them from power. Power on all routers, switches, the Maxtor Shared Storage Drive, computers, and finally media players.

MAXTOR SHARED STORAGE II MACINTOSH INSTALLATION

Introduction

Thank you for selecting the Maxtor Shared Storage II Drive.

Connecting this storage solution to your network in a home or small office is a simple and economical way for users to share and backup files. Your new Maxtor Shared Storage II drive offers a winning combination of capacity, simplicity of use and helpful software features that automate configuration, privacy and more. The simple installation allows you to start using your drive as quickly as possible. You can also change settings on your drive at any time, and manage user access through Safari or other web browsers.

Shared Storage II Features

Instantly add storage to your network, back up files across every compatible Macintosh on your network, and stream music, videos and photos from your drive to your home entertainment system.

Simple Installation and Setup

- Automatically configure the drive to your network
- Manage the drive using our simple user interface
- Connect and share additional hard drives using the drive's 2 USB ports
- Easily store and share access to files, photos, music and videos
- Organize files automatically using Drag and Sort™
- Give users full access to public folders, while keeping others private
- Get backup and storage status for all users with SimpleView™
- Back up user files/folders to an external USB drive
- Protect data on all of your networked Macs using Maxtor® Backup
- Playback of Videos, Music and Photos
- Use our media streaming feature to play digital photos, music and video on a networked home entertainment system - even without turning on your Macintosh
- Connect automatically through a UPnP™ AV compatible digital media adapter

About this Guide

The following symbols and conventions are used in this guide:

Bold Used for menu, command, and keyboard selections you make and screens you will see.

Italics Used for emphasis and to identify new terms.

Components

Before installing, review the solution features in Figure 1.

FIGURE 1 SOLUTION FEATURES

1. Status Lights
2. Power Switch
3. Power Connector
4. USB 2.0 Ports
5. Ethernet Port
6. Security Lock

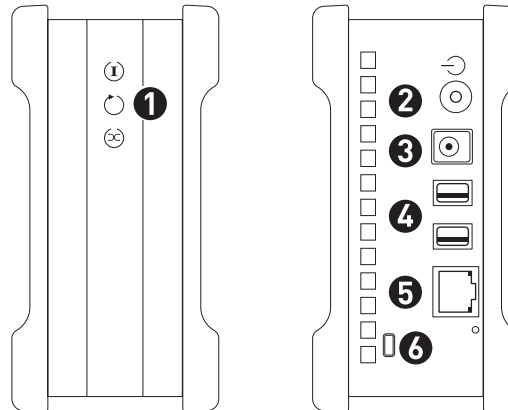

MAXTOR SHARED STORAGE II MACINTOSH INSTALLATION

FIGURE 2 INCLUDED IN PACKAGE

1. Backup Solution
2. Power Adapter
3. Cat5 Ethernet Cable
4. EasyManage CD

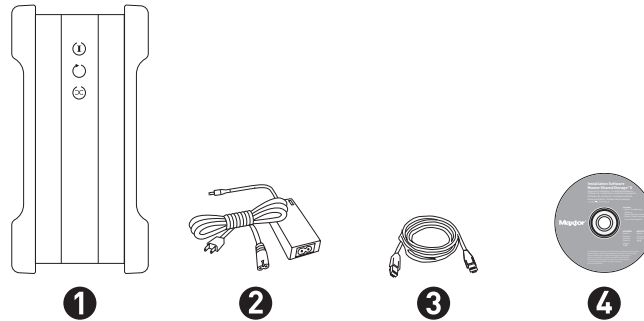

System Requirements

- Wired or wireless router with an available 10/100/1000 Ethernet port
- Apple G4 processor or greater
- Mac OS X (10.3.9 or later)
- 256MB RAM (512MB recommended) or more as required by operating system
- Internet Explorer 6.0 or higher (for management interface of the Shared Storage II drive)
- Internet connection (for system updates)
- UPnP certified Digital Media Adapter (if using Media Serving)
- CD-ROM/DVD-ROM drive

Handling Precautions

Please handle your new Maxtor Shared Storage II with care!

Follow the precautions listed here or you could damage your drive and void the product warranty. Review the Maxtor Limited Warranty for more information.

Follow these precautions to prevent data loss

- Do not bump, move or drop the drive while in operation.
- Do not remove the interface cable or power cord without first disconnecting the drive properly through the operating system.
- Do not set any liquids or drinks on or near the drive. Liquids will damage the internal electronics.
- Do not open the drive enclosure. This can cause loss of data and will void the product warranty.

Maxtor Product Support

Maxtor Corporation provides a comprehensive product support section on its web site, including the latest software drivers, product specifications, a complete troubleshooting section, and the Maxtor Knowledge Base.

Maxtor USA Support

Visit www.maxtorkb.com for the following information:

- **Search the Hard Drive Knowledge Base**
We store all resolved problems and FAQ's in our knowledge base. Search by product, category, keywords, or phrases.
- **My Stuff**
Login to modify or view your FAQ update notifications or update your personal profile.
- **Most Popular Help Topics**
Top five most frequently asked questions.
- **Software Download**
Download installation and diagnostic programs for your hard drive or external storage device.

Maxtor Worldwide Support

Visit www.maxtor.com and click **worldwide support** or **contact us** for product support outside of the USA.

MAXTOR SHARED STORAGE II MACINTOSH INSTALLATION

Installing the Shared Storage II

Step 1 – Connect the Drive

The Maxtor Shared Storage II connects to your computer with a Cat5 Ethernet cable.

Connecting the Ethernet Cable

1. Plug one end of the Ethernet cable into your network, router or switch.
2. Plug the other end of the Ethernet cable into the Ethernet port on your Shared Storage II drive.
3. Once connected, the Ethernet status LED(s) located on either side of the Ethernet port will illuminate:
 - If connected through a 10/100 cable/router – the Green LED on the left side of the connector will show activity when the Shared Storage Drive is powered on. This LED will also illuminate when connected to a Gigabit cable/router too.
4. If connected through a Gigabit cable/router – the Amber LED on the right side of the connector will show activity when the Shared Storage Drive is powered on.

FIGURE 3 CONNECTING THE ETHERNET CABLE

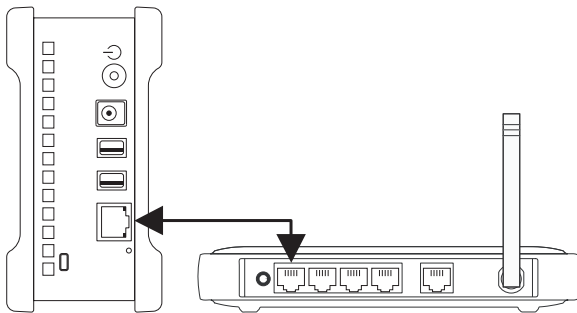

Connecting the Power

1. Plug the round female connector from the power adapter into the drive's power connector.
2. Plug the female connector on the power cord into the power adapter.
3. Plug the standard electrical plug from the power adapter into your power source.

FIGURE 4 CONNECTING THE POWER

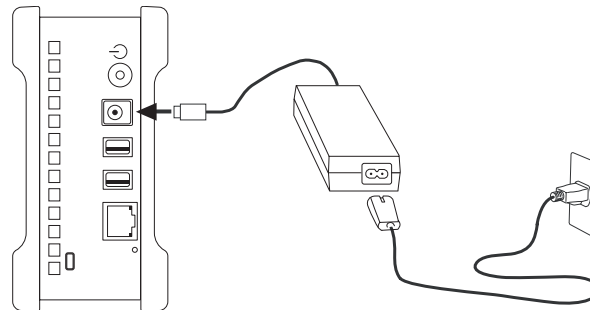

MAXTOR SHARED STORAGE II MACINTOSH INSTALLATION

Step 2 – Power up the Drive

1. Press the round black button on the back panel of your Maxtor Shared Storage Drive. The green LED (light) will illuminate in the center of the power button.

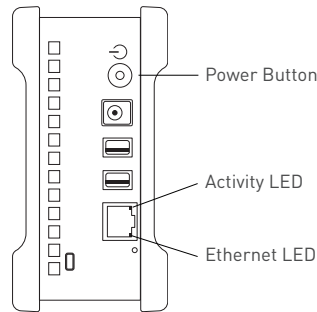

2. Your drive will now start. The startup process can take up to one minute to complete.

Shared Storage Drive Power/Status LED Definitions

Various LED activity will appear on your Shared Storage II Drive when power is applied. The following tables define the meaning/status of each LED on the back and front panels:

Back Panel LEDs

LED	Definition	Status
Power LED (located in center of the power button)	Power switch	Illuminated – Power On Not Illuminated – Power Off
Ethernet LED (located on bottom side of Ethernet connector)	Shows if the drive is connected through a 10/100 or a 1 Gb Ethernet connection. Left Green – 10/100 Mbps Ethernet connectivity Left Amber – 1 Gbps Ethernet connectivity	Illuminated – Power On Blinking – Network communication is occurring Not Illuminated – Power Off
Activity LED (located on top side of Ethernet connector)	A flashing Activity LED indicates that the network connection is functional and that packets are being transmitted or received.	

Front Panel LEDs

LED	Definition	Status
Top	Power Activity	Illuminated – Power On Blinking – Drive is either powering up or shutting down Not Illuminated – Power Off
Center	Hard Disk Activity	Illuminated – Power On Blinking – Data is being transferred to/from the drive Not Illuminated – Power Off
Bottom	Network Activity	Illuminated – Power On Blinking – Network communication is occurring Not Illuminated – Power Off

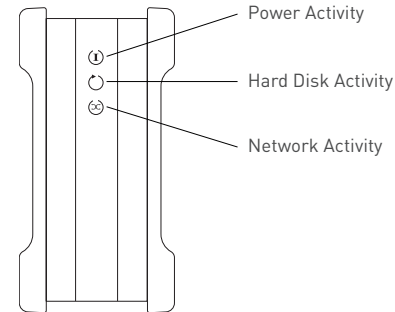

MAXTOR SHARED STORAGE II MACINTOSH INSTALLATION

Step 3 - Setup the Drive

1. Insert the Maxtor Shared Storage II Installation Software into your CD-ROM drive and double-click the **Install CD** icon.
2. Then double-click the **Maxtor EasyManage.pkg** icon to launch the program.
3. From the Welcome screen, click **Continue**.
4. Review the License Agreement and click **Continue**.
5. To accept the terms of the License Agreement, click **Agree**.
6. Select a **destination** to install the EasyManage software and click **Continue**.
7. To start the installation, click **Install**.
8. When prompted, type your **Name** and **Password** of the user to authenticate. Click **OK** to proceed.
9. A restart is required to complete the installation. Click **Continue Installation** to proceed.
10. The EasyManage software will install on your computer.
11. When finished, click **Restart**.
12. When the computer is ready, double-click the **EasyManage** icon.
13. The EasyManage software will begin locating Shared Storage Drives detected on the network.
14. When found, you will see the Network ID number and IP address for the located drive(s). For example:
MSS-0170CA (192.169.1.108).
15. The EasyManage - Shared Storage Administrator Password window will appear for all new drives, allowing you to set administrative security on the Shared Storage drive.
16. Click **Yes** to launch the **Web User Interface** and set an administrative password.

Note: See "The Web UI" later in this guide for details on using the Maxtor Shared Storage Web UI - Shared Folder Backup for more information on configuring these settings.

MAXTOR SHARED STORAGE II MACINTOSH INSTALLATION

Using the Shared Storage II

Using EasyManage

Once installed, you can use your new Maxtor Shared Storage II in the same way you use the other drives on your computer. Some of the basic ways you can use your new drive are:

Select Your Drive

Make sure your Shared Storage Drive is connected to your network and turned on. Its name and IP address will appear in the “Select a Maxtor Shared Storage Drive” list.

1. Double-click the **Maxtor EasyManage** icon located on your Desktop.
2. Click the **name** of your Shared Storage Drive in the list.
3. Select a **user account**.
4. Click **Select Drive**.
5. If it is a private account, enter the password and click **OK**.

A shortcut to the shared folder for this user account will appear on the desktop of your Macintosh.

Note: If you are already connected to an account and want to connect to another account on your Shared Storage Drive, you do not need to select the drive (step 3, above). If you are setting up your Shared Storage Drive for the first time, you will need to create a user account.

Maxtor EasyManage Help

Help can be accessed from:

- The Help Button located on the EasyManage main menu.
- The Help Menu located at the top of the desktop.

When selecting one of these options, the Help Menu is displayed.

Create and Use Shared Folders

User Account Types

Public – With a public account, all of your files are accessible to anyone who has an account on your Shared Storage Drive.

Private – With a private account, all of your files are password-protected except for those which you place in your “Public” folder to share with others.

Name and Password

Length – Name may be up to 20 characters in length. Password may be up to 32 characters in length.

Characters – Both may contain letters, numbers, and underscores (`_`), but no spaces or symbols.

Creating Shared Folders

Shared Folder Types

While creating a user account you can select a shared folder type to associate with the user. You can choose between three shared folder types:

Home – With this folder type, a series of sub-folders are created that help with organizing files/folders commonly used in the Home environment (My Music, My Documents, etc.). A shortcut to the Public folder is provided as well.

Business - With this folder type, a series of sub-folders are created that help with organizing files/folder commonly used in a business environment (My Documents, My Spreadsheets, My Presentations, etc.). A shortcut to the Public folder is provided as well.

None - With this folder type, no sub-folders are created; however, there is a shortcut to the Public folder.

Note: The Public account, for all users, contains a set of folders identical to the Home folders shown above, but using the name “Our.” For example: “Our Music.”

MAXTOR SHARED STORAGE II MACINTOSH INSTALLATION

Creating a Public/Home User Account

1. From the main **EasyManage** screen, click the **Create a User Account** button.



2. Select the **Public User Account** type.
3. Select the **Home Folder** type.
4. Type a **Name** for your shared folder.
5. Click **Create**. At this point, the account is created (this may take a few minutes to complete).
6. When created, the word **"Success"** will appear near the help button and a shortcut to the shared folder for this user account will appear on the desktop.



7. Double-click the **shortcut** to view its contents.

Creating a Public/Business User Account

1. From the main **EasyManage** screen, click the **Create a User Account** button.



2. Select the **Public User Account** type.
3. Select the **Business Folder** type.
4. Type a **Name** for your shared folder.
5. Click **Create**. At this point, the account is created (this may take a few minutes to complete).
6. When created, the word **"Success"** will appear near the help button and a shortcut to the shared folder for this user account will appear on the desktop.



7. Double-click the **shortcut** to view its contents.

Creating a Public/None User Account

1. From the main **EasyManage** screen, click the **Create a User Account** button.



2. Select the **Public User Account** type.
3. Select the **None Folder** type.
4. Type a **Name** for your shared folder.
5. Click **Create**. At this point, the account is created (this may take a few minutes to complete).
6. When created, the word **"Success"** will appear near the help button and a shortcut to the shared folder for this user account will appear on the desktop.



7. Double-click the **shortcut** to view its contents.

Creating a Private/Home User Account

1. From the main **EasyManage** screen, click the **Create a User Account** button.



2. Select the **Private User Account** type.
3. Select the **Home Folder** type.
4. Type a **Name** for your shared folder.
5. Type and re-type a **Password**.
6. Click **Create**. At this point, the account is created (this may take a few minutes to complete).
7. When created, the word **"Success"** will appear near the help button and a shortcut to the shared folder for this user account will appear on the desktop.



8. Double-click the **shortcut** to view its contents.

MAXTOR SHARED STORAGE II MACINTOSH INSTALLATION

Creating a Private/Business User Account

1. From the main **EasyManage** screen, click the **Create a User Account** button.



2. Select the **Private User Account** type.
3. Select the **Business Folder** type.
4. Type a **Name** for your shared folder.
5. Type and re-type a **Password**.
6. Click **Create**. At this point, the account is created (this may take a few minutes to complete).
7. When created, the word **“Success”** will appear near the help button and a shortcut to the shared folder for this user account will appear on the desktop.



8. Double-click the shortcut to view its contents.

Creating a Private/None User Account

1. From the main **EasyManage** screen, click the **Create a User Account** button.



2. Select the **Private User Account** type.
3. Select the **None Folder** type.
4. Type a **Name** for your shared folder.
5. Type and re-type a **Password**.
6. Click **Create**. At this point, the account is created (this may take a few minutes to complete).

7. When created, the word **“Success”** will appear near the help button and a shortcut to the shared folder for this user account will appear on the desktop.



8. Double-click the **shortcut** to view its contents.

Using Shared Folders to Connect to User Accounts

There are two (2) methods for connecting to User Accounts. This section provides you with the steps for connecting a Public or Private User:

Method 1 – Connect a Public User Account

1. From the main **EasyManage** screen, click the **Connect to a User Account** button.



The **Connect to User Account** window is displayed.

2. Select the **Public User Account** that you wish to connect.
3. Click **Connect**. At this point the **EasyManage** software connects to the user account.
4. When connected the word **“Success”** will appear near the help button and a shortcut to the shared folder for this user account will appear on the desktop.



MAXTOR SHARED STORAGE II MACINTOSH INSTALLATION

Method 2 – Connect a Private User Account

1. From the main **EasyManage** screen, click the **Connect to a User Account** button.



The **Connect to User Account** window is displayed.

2. Select the **Private User Account** that you wish to connect.
3. Type the **Password**.
4. Click **Connect**. At this point, the EasyManage software connects to the user account.
5. When connected the word "Success" will appear near the help button and a shortcut to the shared folder for this user account will appear on the desktop of your Macintosh.



Drag and Sort™

Drag and sort is an easy and powerful way to sort files on your Shared Storage Drive. When you drag a group of files to the Shared Storage Drive icon, each file is automatically sorted into a specific folder, based on its file type.

Enable Drag and Sort

This turns Drag and Sort on or off. It is turned on by default when you install the Shared Storage Drive software. You may also control this setting using the Drag and Sort button in the main EasyManage screen.



Note: Drag and Sort can also be enabled and/or disabled from the Settings – Drag and Sort menu.

Folders and their Sorted File Types

Two types of folder sets exist on your Shared Storage Drive:

- "My" folders - a set of folders unique to each user.
- "Our" folders - a set of folders for all users.

Files dragged to a user-specific shared folder are sorted into the "My" Personal Folders. Files dragged to the Public shared folder are sorted into the "Our" Public Folders.

"My" Personal Folders and their Sorted File Types

* Business user account folders.

"Our" Public Folders and their Sorted File Types

MAXTOR SHARED STORAGE II MACINTOSH INSTALLATION

Adding Drag and Sort Folders

To add a new folder:

1. Click the plus sign (+) at the bottom of the column. A sheet will drop down where you can enter the new folder name.
2. After clicking **OK**, the new folder will appear in the list in alphabetical order.

Adding Drag and Sort File Types

To Add a New File Type:

1. Select the **folder** in which you want to store the new file type.
2. Click the plus sign (+) at the bottom of the File Types column. A sheet will drop down where you can enter a new file type.
3. After clicking **OK**, the new file type will appear in the list in alphabetical order.

Note: To add a file type, you need to know its extension. For example: *.DOC for a text file.*

Backup Settings

To Launch Your First Backup

1. From the **EasyManage** menu, click **Settings**.



2. This will launch the **EasyManage Settings** menu. By default, **Backup** is selected. If necessary, click the **Backup** tab. You will see the following:

Select Folders to Back Up

1. Click the plus sign (+).
2. From the Finder window, select a folder and click **Open**.

Repeat steps 1 and 2 to add additional folders or select multiple folders in a list by holding down the command key while clicking each folder.

3. To launch an immediate backup, click **Back Up Now**.
4. At this point, the backup will prepare. Files will start backing up to the Shared Storage Drive.
5. When finished, a message will be displayed notifying you that the backup has completed.

MAXTOR SHARED STORAGE II MACINTOSH INSTALLATION

Editing Backup Settings

Set Day and Time

Choose a time for your backup by clicking the arrow buttons or typing. Then choose day(s) by clicking them.

Enable Scheduled Backups

This turns scheduled backups on or off.

You may also control this setting using the Scheduled Backup button in the main EasyManage screen.

Back Up Now

After you've selected the folders to back up, the day and the time, you can back up your folders immediately by clicking **Back Up Now**.

Historical Versions

When you back up your files, you have the option to store previous, or "historical," versions of each file. You can then restore any historical version based on the date when it was backed up.

1. Click the drop menu.
2. Choose the number of historical versions from the menu. By default, 5 historical versions of each file are stored.

Delete History

This deletes all but the most current historical version of each backed-up file, creating extra space on your Shared Storage Drive.

1. Click **Delete History**. The deletion begins.
2. When finished, the message "Delete history" will display.

Delete Unused

This deletes all backed-up files from your Shared Storage Drive that no longer exist on your Macintosh, creating extra space on your Shared Storage drive.

1. Click **Delete Unused**. The deletion begins.
2. When finished, the message "Delete Unused has completed" will be displayed.

Advanced Settings

To open, click **Tab Advanced**. The following options are displayed:

Wake My Macintosh if it is Asleep

Select this option to automatically wake up your Macintosh, so the backup can take place. If you do not select this option, you will need to manually wake up your Macintosh before backup can start. This option is enabled by default.

Start My Macintosh if it is Not Running

Select this option to automatically start your Macintosh, so that backup can take place.

This requires that the "automatically log in..." option is selected for your Mac OS X user account.

If you currently log in manually and would like to switch to automatic login:

1. Go to the Apple Menu and choose **System Preferences**.
2. Click **Accounts**.
3. Click the lock at the bottom of the window.
4. Type your **password** and click **OK**.
5. Select your **user account**.
6. Click **Login Options**.
7. Click **Automatically log in as**.
8. Choose your **user name** from the drop-down list.
9. Type your **password** and click **OK**.
10. Click **Login**.
11. The browser then launches to the Maxtor Shared Storage Drive – home page.

Shut Down My Macintosh when Backup is Finished

This option is only available if the **Start My Macintosh if it is Not Running** is checked. When selected, your Macintosh will shutdown after a scheduled backup has completed.

MAXTOR SHARED STORAGE II MACINTOSH INSTALLATION

Shared Storage Administration

The button launches the Shared Storage Drive's Web User Interface (Web UI).

Note: You must login as the admin user to use the Web UI.

To Access this Feature

1. Open **EasyManage** and click on the **Settings** button.
2. From the Settings screen, click **Advanced Web Page**. This will launch the Web UI. If prompted, type the User name and Password to authenticate.

The admin user can select this option to configure the Shared Storage Drive's:

- Language
- Network Time Protocol
- Date/Time Format
- Date
- Time
- Computer Name
- Workgroup Name
- Password

Note: See "The Web UI" later in this guide for details on using the Maxtor Shared Storage Web UI. Run Set-up Wizard for more information on configuring these settings.

Drag and Sort™

Drag and Sort is an easy and powerful way to sort files on your Shared Storage II Drive. When you drag a group of files to the Shared Storage Drive icon, each file is automatically sorted into a specific folder, based on its file type.

Note: See "Drag and Sort™" on page 31 for more information regarding the use of this feature.

Backup

Connect to My Selected User Account at Login

Select this option if you want to connect to the selected User Account when you login to your Mac computer.

If configured through settings, you can launch a backup from EasyManage.

1. Click the **Back Up** button. The backup prepares to launch, then starts to backup the files to your Shared Storage Drive.



2. When finished, a screen notifies you that the Backup completed.
3. Click the **red button** to close the screen.

MAXTOR SHARED STORAGE II MACINTOSH INSTALLATION

Restore

Restore Recent Files and Folders

You can restore the most recent version of backed-up files and folders.

Select a File or Folder

1. From the EasyManage main menu, click the **Restore** button.



2. Click the arrow next to the hard drive where the current files are stored to reveal the folders from which files or folders were backed up.
3. Click the arrow next to each folder to reveal its contents until you find the specific files and/or folders you wish to restore.
4. Click the checkbox next to the files and/or folders you wish to restore.

or

To restore a historic version of a file, click the latest drop down menu and select the Historic file version that you wish to restore.

Select a Restore Location

Original: Restores file(s) to their original location, replacing the existing version.

Temporary: Restores files to the temporary location in the Documents folder of the current user. For example: `/Users/John/Documents/Maxtor Restore`.

Restore the files and folders

After you've selected the file(s) and the restore location, click Restore.

Historical Versions

When you back up your files, you have the option to store previous, or "historical," versions of each file. You can then restore any historical version based on the date when it was backed up.

You can choose the number of historical versions from the Historical Versions pop-up menu in the Backup Settings window. By default, 5 historical versions of each file are stored.

MAXTOR SHARED STORAGE II MACINTOSH INSTALLATION

SimpleView™ Storage and Backup Status

This screen provides you with an overview of each user's storage and backup information:

Click SimpleView.



Last Backup	Date of the user's latest backup
Space Used	Total size of all user's files
Backup Status	Success of user's last backup

The following displays:

Backup Status Indicators

Icon	Status	Meaning
	Complete	All files successfully backed up
	Incomplete	Some files backed up
	Failed	No files backed up

Backup Log File

You can see the details of a user's backup by reading the log file. To view the log file, double-click the icon in the Status column.

The log files launches in a Console window.

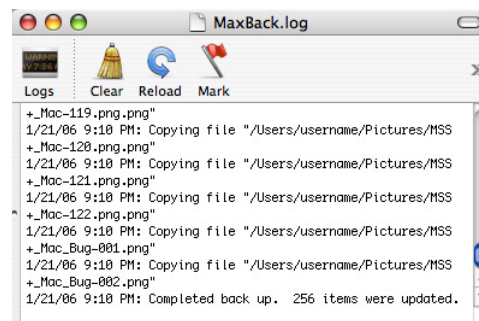

Using Media Server



Use Media Server to Manage Your Digital Photo, Music and Video Collection

If you have a networked home entertainment system, you can use Media Server to manage your digital photo, music and video collection on your Shared Storage Drive and use it with your entertainment system. Media Server can even search your iTunes Music folder for music and video files.

Media Server recognizes files in the following folders on your Shared Storage Drive: Our Photos, Our Music, Our Movies, My Photos, My Music, My Movies or My Multimedia. By placing your files in these folders, they will automatically be available for use with your entertainment system. In order to use Media Server, your entertainment system will need to be compatible with UPnP (Universal Plug and Play).

To enable Media Server on your Shared Storage Drive, click the Media Server button in the main EasyManage screen.

To enable Media Server:

1. From the EasyManage menu, click the **Media Server** button.
2. This will launch your browser. When prompted, type the **User Name** and **Password** to authenticate.
3. Click **Login**.

This will launch your browser directly to the Manage Digital Photos, Music, and Video page.

Note: See "The Web UI" later in this guide for details on using the Maxtor Shared Storage Web UI - Manage Digital Photos, Music, and Video for more information on configuring these settings.

MAXTOR SHARED STORAGE II MACINTOSH INSTALLATION

Storing Audio

Using your computer as an audio jukebox is a very popular application. This allows you to store and play thousands of your favorite songs. You can also create and manage an audio library from your Maxtor Shared Storage II.

Shutting Down Your Shared Storage II Drive

To Shut Down Your Drive

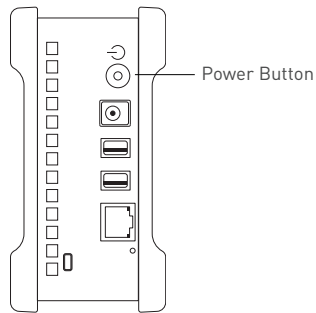

1. Press the round black button on the back panel of your Maxtor Shared Storage Drive. Upon doing so, the power status button on the front panel of the Shared Storage Drive will blink rapidly.

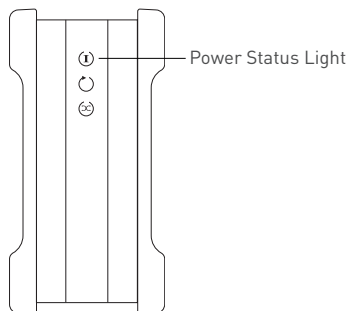

The power down sequence will take 1 – 10 seconds to complete. When properly shutdown, all LEDs on the front and back will no longer be illuminated.

Resetting Your Shared Storage II Drive

If you can not access your drive after moving it to another network, turning it on after it has been off for a period of time, or if you have forgotten/lost the admin password it may need to be reset.

To Reset Your Drive

1. With the drive turned on, use the tip of a pen or paperclip, then press and hold the reset button on the back of your drive. After a few seconds, the drive will reboot.

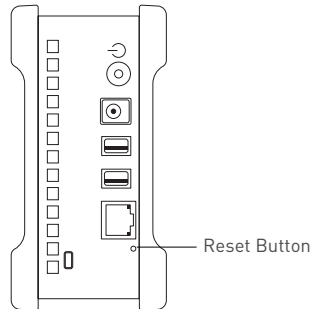

2. The power status LED will return to a blink state of about 1 second between blinks. The reset is complete and your drive is ready for use.

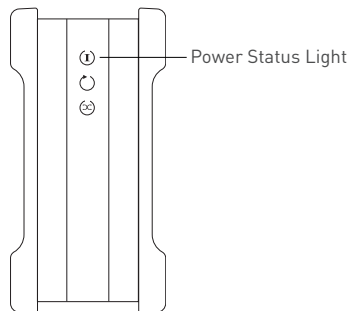

After Resetting Your Drive

- The admin password will be removed
- The computer name will reset back to its default name
(Example: MSS-000155)
- The workgroup name will be reset to MSHOME

MAXTOR SHARED STORAGE II MACINTOSH INSTALLATION

Note: See “The Web UI” later in this guide for details on using the Maxtor Shared Storage Web UI. Run Set-up Wizard for more information on re-configuring these settings.

Security Lock

Your new Maxtor Shared Storage II includes a security locking slot on the back of the drive. The slot is compatible with most security locking cables.

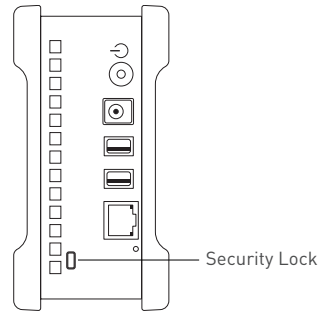

Media Servicing

With the Shared Storage Drive's Media Servicing capabilities, you can view videos or photos and listen to music on your home entertainment center without ever turning on your computer. The Media Server feature is disabled by default on the Shared Storage Drive.

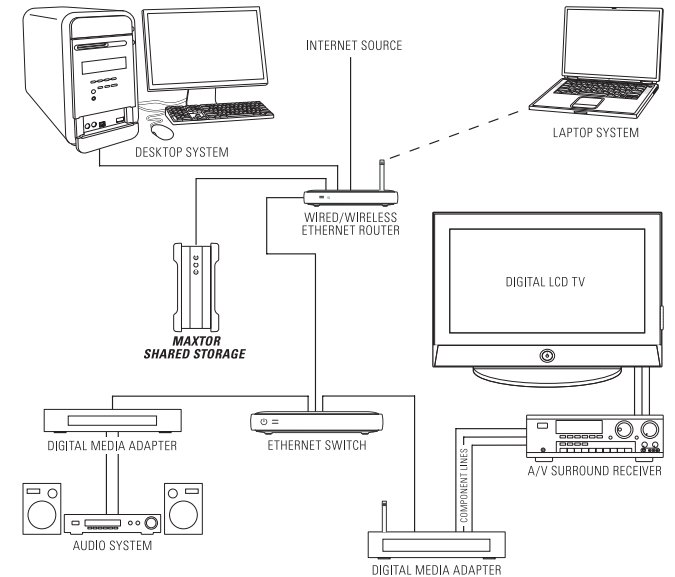

Once your Shared Storage Drive is properly connected to your network, you can copy music, movies, or videos directly to it. Next, connect an UPnP™ AV compatible digital media adapter (DMA) through your router, and your home network becomes a home entertainment center.

MAXTOR SHARED STORAGE II MACINTOSH INSTALLATION

Considerations for Home Media Networks

- Some data may not be available for access for up to two (2) hours after being copied to the Shared Storage Drive. To obtain immediate access to these media files, click the Refresh button located in Web UI.
- Take a survey and note all of the wireless devices in your household (e.g., radio's, stereo's, speakers, phones, cell phones, microwave ovens, alarms, etc.).
- Use of a hand held WiFi detector will help determine strength and weakness of WiFi signals in your home.
- Be suspicious of any wireless devices in the same general area and remove them from the WiFi paths of your routers and media players.
- In some cases, firewalls may need to be disabled and re-enabled.
- Most wireless devices broadcast a wireless frequency by default. Check the documentation of your wireless media players for configuration (WEP) settings.
- Check that your wireless router (WEP) security settings will allow detection and connection of new devices.
- Try moving your media player within a couple of feet of your wireless router for configuration and connection.
- When configuring and detecting wireless devices, keep an Ethernet cable handy to hard wire the devices together for diagnosis.
- If you continue to have problems with your WiFi connection dropping off line, consider hardwiring the devices with Cat5e Ethernet cabling.
- If you're still having detection issues, reset all network devices by physically unplugging them from power. Power on all routers, switches, the Maxtor Shared Storage Drive, computers, and finally media players.

MAXTOR SHARED STORAGE II WEB USER INTERFACE

Web User Interface

The Web User Interface (Web UI) is used for the following actions:

- Setup the Shared Storage Drive (Language, Date/Time Settings, Administrative Password, etc.)
- Create/Manage User Accounts
- Create/Manage Shared Folders
- Advanced Settings - configure network settings, adjust power settings, perform diagnostics, setup USB devices (external drives, printers)
- View Drive Status

Accessing the Web UI

To Open or Start the Web UI

1. Through your browser application:

- **By Network ID** - Each Shared Storage Drive has its own Network ID. The Network ID is located on the label located on the back panel of the Shared Storage Drive. Locate the label on the back panel and find the text, MSS Network ID: mss-xxxxxx; "mss-" are the first four characters found at the beginning of each Network ID and the "x" are denoted by numeric characters - for example, 123456); then to access the Web UI:
- Launch your computer's web browser (e.g., Microsoft Internet Explorer) and type the following in the address field: *http://mss-xxxxxx/*

For example, if the Shared Storage Drive's Network ID is 123456, you would type: *http://mss-123456/*

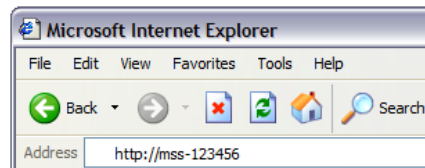

- **By IP Address** - Each Shared Storage Drive has its own IP Address, whether it is Static, assigned from a DHCP Server, or by default via Automatic Private IP Addressing (APIPA). To launch the Web UI via its IP Address if the Shared Storage Drive's address is 169.254.26.69, you would type: *http://169.254.26.69*

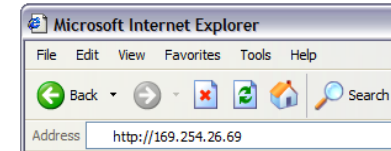

2. Through the Maxtor EasyManage software, you can launch the Web UI. To do so:

- Start **Maxtor EasyManage** software.
- For Windows: Click **Settings** → **Advanced Web Page**.
- For Macintosh: Click **Settings** → **Advanced** → **Shared Storage Administration**.
- At this point, your web browser launches. Type in your **administrative username** and **password** for authentication and click **OK**.

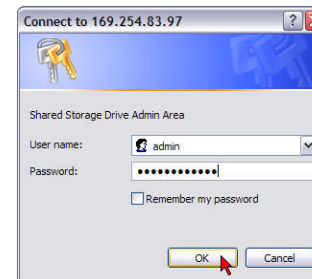

The Shared Storage II Drive - Home Page opens in your browser. The Web UI is used to administrate the Shared Storage Drive via a simple, but thorough web interface.

In the following pages, you will learn how to use all features of the Web UI.

MAXTOR SHARED STORAGE II WEB USER INTERFACE

Run Set-up Wizard

The Run Set-up Wizard will aid in the initial configuration of your Shared Storage Drive. From the Wizard, you can:

- Change the language used by the Web UI
 - Manually set Date/Time or enable/configure a Network Time Server
 - Name your Shared Storage Drive and assign it to a workgroup
 - Create the administrative password to secure the administrative functionality of the Shared Storage Drive
1. From the Maxtor Shared Storage Drive – Home Page, click **Run Set-up Wizard**.



The following page is displayed:

Step 1 of 2

Use this page to enter your language preference, today's date, and the current time. To change the date and time later, use the **Advanced, Language, Date and Time** settings page.

To Select the Language

1. Use the pull down menu and select your language.

Network Time Protocol

This option allows the Shared Storage Drive to maintain time via an Internet time server. By default, this feature is disabled.

Note: This feature can only be used if the Shared Storage Drive is connected to the Internet.

1. To enable the Network Time Protocol, click **Enable**.
2. Choose a **continent** (Asia or Europe), **country** (USA) or a **user defined NTP server name** as the default NTP server. If you choose to use a user defined NTP server name, enter the name in the field provided.

3. Select your **Time Zone**.
4. To disable the Network Time Protocol feature, click **Disable** and then click **Next**.

To Set the Date

Note: Skip this step if Network Time Protocol was configured.

1. Type in the **Date** using the (mm/dd/yyyy) format.

To Set the Time

Note: Skip this step if Network Time Protocol was configured.

1. Type in the **current time** using the (hh:mm:ss) format, make sure to indicate AM or PM.
2. Click **Next**.

Step 2 of 2

Use this page to assign the Shared Storage Drive a network name, identify the workgroup (Domain) to which it belongs, and to add/change the Admin password for your Shared Storage Drive.

To Set the Name of Your Shared Storage Drive

1. Enter the name of your choice in the **Name** field.

To Set the Workgroup (Domain) that you would like your Shared Storage Drive to be in

1. Enter the **Workgroup** (Domain) name of your choice in the **Workgroup** field.

To Set an Administrator Password

1. Select the **Yes** button to indicate that you want to have a password on the Administrator account.
2. Type in the **new password** and then verify the password by retyping it.
3. Click **Next**.

MAXTOR SHARED STORAGE II WEB USER INTERFACE

Note: If you do not want an Administrator password on your Shared Storage Drive, select the **NO** button indicating that you do not want to assign an Administrator password and then click **Next**.

You will be prompted to authenticate using the Administrator's name (admin) and type the newly created administrator password. Click **OK**.

Configuration Complete

After completing the Set-up wizard, you should see a **Congratulations** message followed by an overview of all of the settings that were made. Please take a minute to either print or write down the information for future reference.

To print the summary of your Shared Storage Drive

1. Click the **print** icon below the information.
2. When finished printing or writing down the information, click **OK** to return to the Shared Storage home page.

Accounts Management



Overview

Use the Accounts Management link to manage the way people access and store information on your Shared Storage Drive.

The Accounts Management page is where you can:

- Create a New User Account
- Modify Account settings and Sharing Privileges
- Delete User Accounts

Using the Accounts Management Pages

- Select what action you would like to do
- If you want to redisplay a page (to change something you entered on it, for example), click **Back**
- After making a change, click **Next**
- Go back and forth between pages until you are satisfied that the information is correct
- To stop and lose your changes, click **Cancel**. You can stop at any time

Creating a New User Account

Add a user to your Shared Storage Drive and you want someone to have a particular level of access to information in a share. You can then define the appropriate level of access for that user to that information.

When Shared Storage Drive is installed, it includes an Admin user by default. Admin is the user name you or whoever else administers Shared Storage Drive use to log in to exercise administrative privileges.

Note: This is the only account that will allow you to login to the Web Administration portion of the Shared Storage Drive.

To Add a User

1. Click **Create A New User Account**.
2. Type the **user name** in the name field. (**Note:** The name must have alpha numeric characters and can be a maximum length of 32 characters.)
3. Type a **password** in the Password field. You must enter a password for the user in order to continue.
4. Click **Next**.
5. Set the permissions for the user account by selecting the appropriate buttons for the folders that you want the user to have access to. **Note:** By default, the user has permissions to all Shared folders on the Shared Storage Drive.
6. Click **Next**.
7. A screen will appear showing that the user was created. Click **OK** to return to the Accounts Management page.

MAXTOR SHARED STORAGE II WEB USER INTERFACE

The user is added and should immediately have access to the Shared Storage Drive.

Modify Account Settings and Shared Privileges

Use this page to change a password as well as modify what shared folders a user has access to on pre-existing accounts.

Note: The Admin account always has access to every folder on the Shared Storage Drive.

To Change Folder Permissions

1. Click **Modify Account Settings** and **Shared Privileges**.
2. Find the user to modify the permissions for and click **Modify**.
3. **Set the permissions** for the user account by selecting the appropriate buttons for the folders that you want the user to have access to.
4. Click **Next**.
5. A screen will appear notifying you that access privileges have been successfully modified. Click **OK** to return to the Accounts Management page.

To Change the Password on a User Account

1. Click **Modify Account Settings** and **Shared Privileges**.
2. Find the user to modify the permissions for and click **Change**.
3. Enter the **new password** for the user.
4. Confirm the password by re-entering it.
Note: If the passwords do not match, an error message will appear.
5. Click **Next**.
6. A screen will appear notifying you that the password has been successfully changed.
7. Click **OK** to return to the Accounts Management page.

Delete User Accounts

To Delete a User Account

1. Click **Delete User Accounts**.
2. Find the user that you would like to remove and click **Delete**.
3. Confirm that you selected the correct user account to delete and click **Yes**.
4. A screen will appear notifying you that the user was successfully deleted. Click **OK** to return to the Accounts Management page.

Note: A User Folder will still remain on the Shared Storage Drive when the User Account has been deleted. Refer to **Shared Folders Management** for the procedure used to delete a shared folder.

MAXTOR SHARED STORAGE II WEB USER INTERFACE

Shared Folders Management



Overview

Use the Shared Folders Management page to manage the way people access and store information on your Shared Storage Drive.

The Shared Folders Management page is where you can:

- Create a New Shared Folder
- Modify Shared Folder Access Privileges.
- Delete, Suspend or Re-Activate Shared Folders.
- Manage Digital Photos, Music and Video for UPnP Audio/Video players connected to you home/office network

Using the Shared Folders Management Page

- Select what action you would like to do.
- If you want to redisplay a page (to change something you entered on it, for example), click **Back**.
- After making a change, click **Next**.
- Go back and forth between pages until you are satisfied that the information is correct.
- To stop and lose your changes, click **Cancel**. You can stop at any time.

Create a New Shared Folder

To Create a New Public Shared Folder

If you create a share that has Public access, this means that all users will be able to access the folder as well as read and write to the folder.

1. Click **Create a New Shared Folder**.
2. Type in the **desired name** for the new shared folder. **Note:** the **Name** can be no longer than 32 characters.

3. Set the Access Privileges at:

- Public shared folder if you would like everyone to have access.

4. Click **Next**.

5. You will see confirmation that the share was successfully created. Click **OK** to go back to the Shared Folders Management page.

6. Click **New** if you want to create another Share on your Shared Storage Drive.

To Create a New Defined Access Shared Folder

If you **Define** the shared folder access you will be able to limit the users that can access the Shared Folder.

1. Click **Create a New Shared Folder**.

2. Type in the desired name for the new shared folder. **Note:** the **Name** can be no longer than 32 characters.

3. Set the Access Privileges at:

- Define shared folder access privileges if you would like to limit user access to this share.

4. Click **Next**.

5. Set User Access for the share by selecting the appropriate buttons for the users that you want to have access to the folder.

- **Full Access** - This will allow the selected user to Read, Write, and Create new files in the selected Shared Folder

- **Read Only Access** - This will allow the selected user to only read the files in the selected shared folder

- **No Access** - This will allow no access to the selected shared folder.

6. Click **Next**.

7. You will see a confirmation that the share was created. Click **OK** to return to the Shared Folders Management page.

Click **New** if you want to create another Share on your Shared Storage Drive.

MAXTOR SHARED STORAGE II WEB USER INTERFACE

Modify Shared Folder Access Privileges

To Change Folder Permissions

1. Click **Modify Shared Folder Access Privileges**.
2. Find the **Share** to modify the permissions for and click **Modify**.
3. **Set the permissions** for the share by selecting the appropriate buttons for the users that you want to have access to the folder.
 - **Full Access** - This will allow the selected user to Read, Write, and Create new files in the selected Shared Folder
 - **Read Only Access** - This will allow the selected user to only read the files in the selected shared folder
 - **No Access** - No access will allowed to the selected shared folder.
4. Click **Next**.
5. You will see a confirmation that the share permissions were successfully set on the selected folder. Click **OK**.

Delete, Suspend or Re-Activate Shared Folders

To Delete a Shared Folder

1. Click **Delete, Suspend** or **Re-Activate Shared Folders**.
2. Find the **Share** that you would like to remove and click **Delete**.
3. Confirm that you selected the correct **Shared Folder** and click **Yes**.
4. It will confirm that the selected **Shared Folder** has been deleted. Click **OK** to return back to the Shared Folders Management Page.

To Suspend a Shared Folder

1. Click **Delete, Suspend** or **Re-Activate Shared Folders**.
2. Find the Shared Folder to Suspend and click **Suspend**.
3. It will confirm that the selected Shared Folder has been suspended. Click **OK** to return to the Shared Folders Management page.

To Re-Activate a User Account

1. Click **Delete, Suspend** or **Re-Activate Shared Folders**.
2. Find the shared folder to Reactivate and click **Reactivate**.
3. It will confirm that the selected **Shared folder** has been **re-activated**. Click **OK** to return to the **Shared Folders Management** page.

MAXTOR SHARED STORAGE II WEB USER INTERFACE

Manage Digital Photos, Music, Video

Media server technology enables digital photo, music, and video playback to networked home entertainment systems. By default, the Media Server is disabled.

To Manage Digital Photos, Music and Videos

1. Click **Manage Digital Photos, Music and Videos**.
2. Click **Enable Media Server**.
3. Click **Next**.
4. Select the shared folders that will be searched for music, videos and/or pictures and click **Next**.

Note: You can only check one (1) iTunes folder at any given time.

5. Click **Done** to return to the **Shared Folders Management** page.

To Refresh Media Server

This option is only available if Media Server is enabled. By default, the Media Server automatically searches for new media files every two (2) hours. To perform an immediate update to the Media Server database, you must refresh it.

1. Click **Manage Digital Photos, Music and Videos**.
2. Click **Refresh**. The Media Server will refresh automatically in the background.
3. Click **Done** to return to the **Shared Folders Management** page.

To Clean Up Media Server

This option is only available if Media Server is disabled. This feature allows you to prevent potential database corruption when the Shared Storage Drive's Media Serving feature is disabled.

1. Click **Manage Digital Photos, Music and Videos**.
2. Click **Clean Up**. The Media Server's database will be cleaned in the background.
3. Click **Done** to return back to the Shared Folders Management Page.

To Disable Media Server

1. Click **Manage Digital Photos, Music and Videos**.
2. Click **Disable Media Server**.
3. Click **Next**.
4. Click **Done** to return to the **Shared Folders Management** page.

Shared Folder Backup



To use this feature, an external USB drive must be connected to the Shared Storage Drive. After connecting, the External Storage unit will require a re-format from the Shared Storage's browser interface.

For connection information, refer to the Shared Storage II User manual regarding the use of external USB drives.

Formatting the External USB drive

This procedure must be followed in order to use the Shared Folder Backup features of the Shared Storage Drive.

1. Connect the external USB drive to your Shared Storage Drive.
2. From the Web User Interface (Web UI), select **Shared Folder Backup**.
3. A page displays notifying you that, "Your backup drive is not formatted properly. Do you wish to format it now?" Select **Yes** to continue.
4. A page will display prompting you to select a USB drive to format. Select the **drive** from the drop-down menu and choose **Next**.
5. A warning will display, notifying you that formatting will erase all data currently on the USB drive. Choose **Yes**.
6. A page appears showing format status of the USB drive. When finished, a page appears notifying you that the drive is formatted and ready for use. Choose **Done** and return to the Shared Folder Backup page.

MAXTOR SHARED STORAGE II WEB USER INTERFACE

Create Backup Set

This option allows you to create a backup of shared files and folders that reside on your Shared Storage Drive.

1. Select **Shared Folder Backup**.
2. From the Shared Folder Backup Home Page, select **Create Backup Set**.
3. From the Create Backup Set page, select the **shared folders** you wish to add to the Backup Set or you can maintain the default, **All Shared Folders** option.
4. Enter a **Name** for your backup set and choose **Next**.
5. You will be prompted to select an external drive to backup to. Select the **external USB drive** from the drop-down menu and choose **Next**.
6. You will then be prompted to create a Backup Schedule. By default, your selected shared folders will backup daily at 10:00 pm; the backup set will also maintain three months of the files located in the backup set.

Make your selections to the backup schedule and choose **Next**.

7. A page opens showing that the Backup Set has been created, and displays the Backup Name, Backup Source, Destination, and Schedule. Choose **Done** and return to the Shared Folder Backup page, or choose **Back Up Now** to launch your first backup.
8. If you select **Back Up Now**, a page launches showing you the status of the backup. When finished, a page opens showing when the backup is complete.
9. Choose **Done** and return to the Shared Folder Backup page.

Delete Backup Set

This feature allows you to delete a backup set stored on the External USB drive connected to the Shared Storage Drive.

1. From the Shared Folder Backup Home Page, select **Delete Backup Set**.
 2. A page opens listing the Backup Sets located on the Shared Storage Drive. Select the backup set you want to delete and choose **Delete**.
- NOTE:** Deleting a Backup Set does not remove files/folders from the external USB drive.
3. You will be asked to confirm that you wish to delete the Backup Set. Choose **Delete**.
 4. A page opens showing the progress of the backup set removal. When complete, choose **Done** and return to the Shared Folder Backup page.

MAXTOR SHARED STORAGE II WEB USER INTERFACE

Back Up

This option allows you to perform an immediate backup of all, or selected Backup Sets.

1. From the Shared Folder Backup Home Page, select **Back Up**.
2. A page opens prompting you to select which backup sets you wish to immediately backup. **Select the backup sets** and choose **Back Up Now**.
3. A page opens showing you the status of the backup. When finished, choose **Done** and return to the Shared Folder Backup page.

Restore

This option will restore data located in a backup set on the External USB drive to the Shared Storage Drive.

1. From the Shared Folder Backup Home Page, select **Restore**.
2. A page opens prompting you to select which backup sets you wish to restore to the Shared Storage Drive. Select the **backup set you wish to restore** and choose **Next**.
3. Select the **Year, Month, Date and Time** that you wish to restore from.

Select the location where to restore your data:

- Public
 - Original location
4. Choose **Restore**.
 5. If you selected to restore to the original location of the data, a page opens warning you that, "...files in the original location will be overwritten with the corresponding backup version you have just selected."
 6. To continue, choose **Restore**.
 7. A page opens showing the status of the restore. When finished, choose **Done** and return to the Shared Folder Backup page.

Advanced Settings



Overview

Use the Advanced Settings page to manage the Language, Date, Time, and Network Settings. As well as, run Diagnostics, set power management options, update the Shared Storage Drive software and manage any USB peripherals that you have attached to the Shared Storage Drive.

From the Advanced Settings You Can

- Set the Language, Date, and Network Time Protocol
- Adjust Network Settings
- Run Diagnostics, set power management and update the software
- Manage any USB peripherals attached to the Shared Storage Drive

Using the Advanced Settings Pages

- Select what action you would like to do.
- If you want to redisplay a page (to change something you entered on it, for example), click **Back**.
- After making a change, click **Next**.
Go back and forth between pages until you are satisfied that the information is correct.
- To stop and lose your changes, click **Cancel**. You can stop at any time.

MAXTOR SHARED STORAGE II WEB USER INTERFACE

Language, Date and Time

Enter your language preference, date, and Network Time

To select the Language

1. Use the pull down menu and select the your **language**.

Network Time Protocol

This option allows the Shared Storage Drive to maintain time via an Internet time Server. By default, this feature is disabled.

Note: This feature can only be used if the Shared Storage Drive is connected to the Internet.

1. To enable the Network Time Protocol, click **Enable**.
2. Choose a **continent** (Asia or Europe), **country** (USA) or a **User defined NTP Server name** as the Default NTP server.

If you choose to use a User defined NTP Server Name, enter the name in the field provided.

3. Select your **Time Zone**.
4. To disable the Network Time Protocol feature, click **Disable** and then click **Next**.

To Set the Date

Note: Skip this step if Network Time Protocol was configured.

1. Type in the **Date** using the (mm/dd/yyyy) format.

To Set the Time

Note: Skip this step if Network Time Protocol was configured.

1. Type in the **current time** using the (hh:mm:ss) format, make sure to indicate AM or PM.
2. Click **Next**.
3. Click **Done** to return to the Advanced Settings page.

Network Settings

Use this page to assign the file server a name, identify the workgroup to which it belongs, and to set the IP configuration of the Shared Storage Drive.

To Set the Name of Your Shared Storage Drive

1. Click **Network Settings**.
2. Enter a **name** for the Shared Storage Drive in the name field.

To set the Workgroup that you would like Your Shared Storage Drive to be in

1. Enter the **Workgroup name** of your choice in the workgroup field.
2. Click **Next**.

To set the IP address on the Shared Storage Drive using a DHCP server (default)

1. Select the button indicating that you would like to obtain an IP address from a DHCP server.
2. Click **Next**.
3. A message will appear indicating that the network settings have been submitted to the Shared Storage Drive.
4. Click **Done** to return to the **Advanced Settings** page.

To set the IP address on the Shared Storage Drive using a STATIC IP address (advanced users only)

1. Select **Network Settings**.
2. Select the button indicating that you would like to use **manual TCP/IP settings**.
3. Enter the **IP Address**, **Subnet Mask**, and **Default Gateway**.
4. Click **Next**. You will see a status and a message asking you to, "...stand by."
5. Once the network settings have been applied, click **Done** to return to the **Advanced Settings** page.

MAXTOR SHARED STORAGE II WEB USER INTERFACE

System Maintenance

Use these pages to run disk utilities and perform diagnostics; modify power management settings, and to update your Shared Storage Drive software.

To Change Power Management Settings

1. Click **Power Management**.
2. Select the **Drive** that you would like to apply power management settings to.
3. Use the pull down menu to select the **time** which you would like the drive to sit idle before "Going to sleep."

Note: By default, the drive inactivity period is set to 1 hour.

4. Click **Next**.
5. It will confirm the amount of time that you set.
6. Click **Done** to return to the **System Maintenance** page.

To Run Diagnostics

1. Click **Diagnostics Scan and Repair**.
2. A warning will appear notifying you that the drive will be inaccessible to users while running. Click **Next**.
3. The diagnostic feature inspects your hard drive for defects.
 - Click **Proceed** to start the diagnostic process.
 - Click **Cancel** if you would like to back up your data first. Selecting **Cancel** will require a re-test.

4. A status bar will appear showing the status of the scan. The Diagnostic process takes between 2 - 5 minutes.
5. Upon successful completion, a window will appear notifying you that your Shared Storage Drive is functioning within normal operating parameters.
6. Click on **Done** to return to the **System Maintenance Options** page. If there are errors that are not repairable, a screen will prompt you with a diagnostics code. Record this error code and contact Maxtor Technical Assistance.

System Update

1. Click **System Update**.
2. A warning will appear notifying you that the drive will be inaccessible to users while running. Click **Next**.
3. Follow the on screen instructions. This process does require a firmware download from the Maxtor website.
4. After the file is downloaded, click the **Browse** button and search for the firmware update.
5. Once the file is selected, click **Update**.
6. A progress bar will show the status of the update. The drive does reboot during this process. You will have a countdown. Once the countdown is finished, close your browser and then reopen it to the Shared Storage Drive home page.
7. Click **Done** to return to the **System Maintenance** page.

MAXTOR SHARED STORAGE II WEB USER INTERFACE

Configure Your USB Devices

Use these pages to configure USB drives and to manage USB printers plugged into the Shared Storage Drive.

Format USB Drive

1. Click **Format USB Drive**.
2. Select the button indicating if you would like to:
 - Re-format the drive and create a single partition
 - Re-format a specific existing partition
3. If necessary, select the **partition** you wish to format and click **Next**.
4. Enter a **Volume name** and click **Next**.
5. A warning will appear stating that if you continue, you will lose all of your data. Click **Next**.
6. You will then see a status page with an elapsed time on it. When the drive has finished formatting, you will see a message that the USB drive has been successfully formatted. Click **Done** to return to the **Configure Your USB Devices** page.

Printer Support Management

1. Click **Printer Support Management**.
2. You will see the current status of your printer support. It will be Enabled or Disabled. Depending on the state, the button on the screen will read to opposite. If the printer support is disabled and you want to enable it, click **Enable**.
3. You will see a message stating that the **Printer Support is enabled**. Click **Done** to return to the **Configure Your USB Devices** page.
4. If Printer Support is enabled and you want to disable it, click **Disable**. You will see a message stating that the **Printer Support is disabled**.
5. Click **Done** to return to the **Configure Your USB Devices** page.

Unplug USB Devices from the Shared Storage Drive

1. Click **Unplug USB devices from the Shared Storage Drive**. It will list all of the USB devices currently plugged into the drive.
2. Click the **Safely Remove** button next to the device that you would like to unplug.
3. A message will appear stating that you can remove the selected device. Click **Done** to return to the **Configure Your USB Devices** page.

MAXTOR SHARED STORAGE II WEB USER INTERFACE

System Status



Overview

Use the System Status page to get a summary of your Maxtor Shared Storage Drive, including IP address, Users and Shares, USB Devices and Printers attached to the unit.

The System Status page is where you can see your current:

- User Accounts and Shares
- Network Settings
- USB devices attached
- Printers

User Accounts

This section will tell you the user accounts that are currently created on your Shared Storage Drive.

Network Settings

This section will tell you the Current Network configuration that is on your Shared Storage Drive, including IP Address, subnet Mask, and default Gateway.

Accounts & Share Status

Click on this link to show a summary of the current accounts and what shares those accounts have permissions to.

USB Devices

This section will tell you what type of devices are attached to the USB ports on the back of the unit. Supported devices are external USB drives and USB flash drives.

Printing Devices

This section will tell you the current status of any printer that is attached to the unit including Manufacturer, Model and Serial Numbers.

Online Help

Your Shared Storage Drive has advanced help features. To access these files, click on the Online Help link at the bottom of the drive file screen.



MAXTOR SHARED STORAGE II WEB USER INTERFACE

Using External USB Drives with Your Shared Storage II

There are 2 USB ports on the back of your drive which allow you to connect USB hard drives, such as the Maxtor OneTouch™ and Maxtor Personal Storage 5000 drives.

Note: The Maxtor Shared Storage Drive is only compatible with USB drives that are formatted with the FAT32 file system. With the FAT32 file system, the size of a single file is limited to 4 GB.

Connecting a USB Drive

You may connect a USB drive while your Shared Storage Drive is on. It will automatically recognize the drive.

You may also connect a USB drive while your Shared Storage Drive is off. It will be recognized the next time you turn your Shared Storage Drive on.

Accessing the external USB Drive

1. Open your Shared Storage Drive by double-clicking its desktop icon.
2. Your external USB drive will appear as a folder on the Shared Storage Drive.

The name of this folder will correspond to the volume name of your external USB drive.

Disconnecting a USB Drive

To disconnect a USB drive from your Shared Storage Drive:

1. Go to the **Maxtor Shared Storage Drive** home page.
2. Click the **Advanced Settings** button.
3. Click **Configure Your USB Devices**.
4. Click **Unplug USB devices from the Shared Storage Drive**.
5. Click the **Safely Remove** button, next to the USB drive you want to disconnect. A message will appear informing you that your drive can be safely removed. Then click **Done**.
6. Disconnect your USB drive from your Shared Storage Drive.

Using USB Printers with Your Shared Storage II

You may connect a USB printer to your Shared Storage II Drive and share it with anyone on your network.

Connecting a USB Printer

- Connect the USB printer while your Shared Storage II Drive is on.
- The printer will appear in the list of shares displayed in the Printers and Faxes folder on your Shared Storage II Drive.

Configuring Network Printing

Configuring a networked USB Printer varies depending on your operating system and/or platform (Windows and/or Macintosh). Please refer to Maxtor's Knowledge Base for more information regarding network printer setup and configurations.

